

StoTherm Retrofit External Wall Insulation Systems

Système d'isolation pour murs extérieurs Wärmedämmung für Außenwand

NSAI Agrément (Irish Agrément Board) is designated by Government to issue European Technical Approvals.

NSAI Agrément Certificates establish proof that the certified products are '**proper materials**' suitable for their intended use under Irish site conditions, and in accordance with Technical Guidance Document (TGD) Part D of the second schedule the **Building Regulations 1997-2023** hereby referred to as the **Building Regulations**.



PRODUCT DESCRIPTION:

This Certificate relates to the StoTherm Retrofit External Wall Insulation Systems. Each system is comprised of:

- Surface preparation of masonry or concrete substrate;
- Full system beads and render-only beads;
- Insulation board (standard white EPS, graphite enhanced silver EPS, mineral wool);
- Adhesive/Reinforcing coat;
- Glass fibre mesh;
- Silicone finish;
- Mechanical fixings;
- Adhesive fixings;
- Weather-tight joints;
- Movement joints;
- Provision for limiting cold bridging at external wall/floor junctions in compliance with Acceptable Construction Details published by the DHLGH;

- Provision for fire stopping at external compartment walls and floors.

Sto Ltd. are responsible for the design, supply of the system, and for the integration of the design of the system into the building. The system is designed by Sto Ltd. on a project specific basis in accordance with an approved design process. The installation of each system is carried out by installers who have been trained and approved by Sto Ltd. and are registered with NSAI Agrément.

In the opinion of NSAI Agrément, StoTherm Retrofit External Wall Insulation System, as described in this Certificate complies with the requirements of the Building Regulations.

USE:

The systems are for use as external insulation for refurbishment/retrofit of existing masonry or concrete buildings, up to a maximum of 5 storeys (15m) in height for the StoTherm Classic 5, StoTherm Vario 6, and the StoTherm Mineral 6 systems in purpose groups 1(a), 1(b) and 1(d) and up to a maximum of 6 storeys (18 m) in height for purpose groups 1(c), 2(a), 2(b), 3, 4(a) and 4 (b) as defined in TGD's to Part B of the Building Regulations. The StoTherm Mineral 6 system is non-combustible with a fire classification of A1 or A2- s1, d0 to IS EN 13501-1^[5] and may be used on heights in excess of this – the Certificate holder must be contacted for the specific build-up, fixing details etc.

The system has not been assessed for use with timber frame, steel frame construction, or ICF (Insulated Concrete Formwork) or new build construction.

MANUFACTURE, DESIGN AND MARKETING:

Manufacturer:
Sto SE & Co. KgaA,
Ehrenbachstraße 1,
79780 Stühlingen, Germany.
T:0049 7744571010
E: infoservice@sto.com

System Design:

Sto Ltd.,
Unit 700, Catesby Park,
Kings Norton, Birmingham, B38 8SE, UK.
T: 0044 330 024 2666
E: info.uk@sto.com
W: www.sto.co.uk

Distributor, Sales and Project Specific Design:

Sto Ltd.,
Unit E7, Riverview Business Park, Nangor Road,
Clondalkin, Dublin, D12 AD93.
T: 01 4602305
F: 01 4602455

1.1 ASSESSMENT

The external insulation systems included in this Certificate, which have been tested in accordance with the requirements of EAD 0400083-00-0404^[7] (ETAG 004^[6]), have been assessed against the specific requirements of the Irish Building Regulations

In the opinion of NSAI Agrément, the StoTherm Retrofit External Wall Insulation Systems; StoTherm Classic 5, StoTherm Vario 4 and Mineral 6, when installed by approved contractors, in accordance with this Certificate and site-specific design, can meet the requirements of the Building Regulations, as indicated in Section 1.2 of this Agrément Certificate.

1.2 BUILDING REGULATIONS

REQUIREMENTS:

Part A - Structure

A1 – Loading

A2 – Ground Movement

Part B – Fire Safety

Part B Vol 2 – Fire Safety

B4 & B9 – External Fire Spread

Part C – Site Preparation and Resistance to Moisture

C4 – Resistance to Weather and Ground Moisture

Part D – Materials and Workmanship

D1 – Materials & Workmanship

D3 – Proper Materials

Part F – Ventilation

F1 – Means of Ventilation

F2 – Condensation of Roofs

Part J – Heat Producing Appliances

J3 – Protection of Building

Part L – Conservation of Fuel and Energy

L1 – Conservation of Fuel and Energy

L2 – Conservation of Fuel and Energy

L4 – Conservation of Fuel and Energy

2.1 PRODUCT DESCRIPTION

Table 1 and 2 list the full list of components of the StoTherm Classic 5, StoTherm Vario 4 and StoTherm Mineral 6 Systems. The systems are adhesively fixed to the external wall with supplementary fixings.

2.2 MANUFACTURE AND SUPPLY AND INSTALLATION

Sto Ltd. is responsible for the design and manufacture of all components to approved specifications. Sto Ltd. are responsible for:

- Project specific design in accordance with approved design process;
- Preliminary project assessment incorporating wind load calculations, U-value calculations, condensation risk analysis, impact resistance, substrate suitability and pull-out testing of fixings;
- Training, monitoring and review of licensed applicators in accordance with approved training and assessment procedures;
- Product supply and documentation control;
- Technical support and installation supervision;
- Sales and marketing.

The installation of StoTherm Systems is carried out by the Certificate holder's trained and approved installers in accordance with project specific specifications and method statements. Installers must also be approved and registered by NSAI Agrément under the NSAI Agrément External Thermal Insulating Composite Systems (ETICS) Approval Scheme.

2.2.1 Quality Control

The Certificate holder, and the manufacturer, operate a quality management system, and a quality plan is in place for system manufacture, system design and system installation.

2.3 DELIVERY, STORAGE AND MARKING

The insulation is delivered to site in the quantities and container types listed in Table 2. Each pack is marked with the manufacturer's details, product identification marks and batch numbers. Components are delivered to site as outlined in Table 2 and 3.

Each container for other components, e.g. mesh, renders, adhesives etc., bears the manufacturer's

and the product's identification marks and batch number, and the NSAI Agrément logo incorporating the Certificate number.

2.4 INSTALLATION

2.4.1 Approved Installers

Installation shall be carried out by Sto Ltd. trained applicators who are registered with NSAI Agrément.

2.4.2 General

Sto Ltd. prepare a site package for each project, in accordance with the NSAI Agrément ETICS Approval Scheme. Deviations must be approved by a Sto Ltd. technical representative. Sto Ltd. technical representatives will visit each site on a regular basis to ensure that work is carried out in accordance with the project specific site package, including the Certificate holder's installation manual. Certificates of Compliance guarantees, and homeowner's manual will be issued on successful completion of completed projects.

Mineral fibre board and lamella must be protected from moisture prior to and during installation. It may be necessary to remove and replace any unsuitable/wet material.

External works that leave the external appearance of the building inconsistent with neighbouring buildings may require planning permission. The status of this requirement should be checked with the local planning authority as required.

To maximise thermal performance, reference should be made to the requirements of Section 2 of the Acceptable Construction Details document (ACDs) from the DHLGH.

This Certificate does not contain a full set of installation instructions, but an overview of the procedures involved. For a full list of these instructions, refer to the Certificate holder's manuals. Should a conflict arise between this Certificate and the Certificate holder's manuals, this Certificate shall take precedence.

2.4.3 Site Survey and Preliminary Work

A comprehensive pre-installation site survey of the property shall be carried out in accordance with the NSAI Agrément ETICS Approval Scheme.

The substrate must be free of water repellents, dust, dirt, efflorescence and other harmful contaminants or materials that may interfere with

the adhesive bond. Remove projecting mortar or concrete parts mechanically as required. Where the substrate contains dash, it must be levelled as much as possible with a layer of adhesive base coat prior to the application of the insulation boards/batts.

In retrofit applications, best practice is to cut back the existing concrete sill to minimise the effects of cold bridging. Where possible the remaining sill should be insulated over prior to the installation of the aluminium.

Where discrepancies exist which prevent installation of the system in accordance with this Certificate and the Certificate holder's instructions, these discrepancies must be discussed with the Certificate holder and a solution implemented with the approval of the Certificate holder.

2.4.4 General

2.4.4.1 Application Procedure

The systems must be installed in accordance with the Certificate holder's instructions. Key points include:

- Prepare substrate in accordance with the project specific Specification & Method Statement. This will include brushing down of walls, washing with clean water and treatment with a fungicidal wash as required.
- Ensure the substrate is sound by checking the substrate surface with a hammer and listening for a hollow sound. If render is loose it must be removed and replaced.
- At external window and door frame reveals the plaster reveals should only be removed if a minimum clearance of 30mm cannot be achieved between the reveal and the window/door frame. This clearance must allow for opening sections of window and door frames. This is to allow the application of insulation around the reveals and heads of the doors and windows to significantly reduce cold bridging.
- Existing concrete sills may be insulated over however best practice is to cut back the concrete sill to minimise the effects of cold bridging at this junction.
- Renders (adhesives, base coats, primers, finish coats) must not be applied if the temperature is below 5°C or above 25°C at the time of application. In addition, cementitious-based renders must not be applied if the temperature will be below 0°C at any time during 72 hours after application, and cement-free, synthetic-resin, silicone-resin and silicate renders must not be applied if the temperature will be below 5°C at any time during 72 hours after application.
- Refer to the Specification & Method Statement for guidance on modifications of down pipes, soil and vent pipes, pipe extensions etc. Where possible, all pipework should be relocated as required to accommodate the insulation. Where pipework cannot be relocated and is to be housed in the depth of the system, access for maintenance must be maintained through the use of a removable cover or similar. Reference should be made to the StoTherm EWI Systems Applicator Training Handbook and the Survey Elevation.
- Base beads and all full system beads are fixed as specified. Adhesive, frame, insulation and render only beads are fixed as specified in the Sto Ltd. Specification & Method Statement.
- A plinth strip/starter track is mechanically fixed to the substrate level with the DPC line. This provides a horizontal line for the installation of insulation panels as well as providing reinforcement to the lower edge of the system. Adjacent starter track profiles are connected using special mounting clips.
- At plinth level, Sto UHD EPS boards are then fixed to the wall below the starter track to provide the necessary resistance to impact and capillary action.
- The insulation boards are bonded to the wall by applying the specified adhesive to the boards.
- When adhesively fixing, care must be taken to ensure an appropriate amount of adhesive is used and that the appropriate adhesive spread and board fixing patterns are used. Reference should be made to the StoTherm EWI Systems Applicator Training Handbook and Figure 11. The adhesive must not be applied onto the sides or fill the gaps between insulation boards. Mechanical fixings are provided in accordance with the project specific design requirements based on pull-out test results (see NSAI Agrément Certificate 09/0331 Table 2).
- Before applying adhesive to mineral wool, the boards must be cleared of dust and loose particles. The boards should be initially covered with adhesive by applying a thin layer using a smooth edge trowel to increase adhesion.
- Subsequent rows of insulation boards are installed on top of the starter track and positioned so that the vertical board joints are staggered and overlapped at the building corners. Vertical joints should be staggered by 500 mm (200 mm minimum). Reference should be made to the StoTherm EWI Systems Applicator Training Handbook .
- To avoid thermal bridging, ensure a tight adhesive free joint connection between adjacent insulation boards. Boards may require rasping to ensure a tight fit. Foam filler approved by the Certificate holder may be used for filling gaps up to 5mm. Larger gaps should be avoided. Where larger gaps greater than 5mm cannot be practically avoided these gaps shall be filled with ETICS insulation

material cut to size and sufficiently fixed to the substrate.

- At façade openings, e.g. window and door opes, full insulation boards must be installed across these openings in elevation and then the insulation is cut back to reinstate the clearance at the opening. This method of installation will minimise the linear length of abutments and joints between boards at openings. In addition, vertical joints should be staggered. Any projecting EPS boards should be levelled out using a rubbing board with local trimming as required on mineral wool boards.
- Window and door reveals should, where practicable, be insulated to minimise the effects of cold bridging in accordance with the recommendations of the Acceptable Details Document published by the DHLGH, Detail 2.21, to achieve an R-value of 0/6m²K/W. Where clearance is limited, strips of approved insulation should be installed to suit available margins and details recorded as detailed in Section 4.4.1 of this Certificate.
- To minimise the effects of cold bridging in all other junctions over and above windows and doors, designers should consider the recommendations of the Acceptable Details Document, Section 2 – External Wall Insulation. Where clearance is limited, strips of approved insulation (with better thermal resistance values) should be installed to suit available margins.
- Details of mechanical fixings (including their arrangement in the insulation boards) are specified in the project specific design based on pull-out test results, substrate type and wind loading data. Installation of mechanical fixings shall commence no earlier than 2 days after the insulation panels have been adhesively fixed.
- Anchors must be installed to the required depth into the substrate, with the head fixed tightly to the insulation board to ensure there is no risk of pull off.
- For drilling holes in thin or cavity materials (hollow block), a drill with an engaged hammer action should not be used. Minimum pull-out resistance of mechanical fixings must be established, alternatively low pull-out values will require an increased frequency of fixing.
- Mechanical fixings should be carefully fitted. The heads of fixings cannot protrude beyond the plane of the boards, i.e. they should be recessed into the insulation and StoThermodowel cap applied. Excessively deep insertion of fixing heads in the insulation material can cause cracking of the boards which in turn weakens the insulation. Filling indentations in these areas can cause thermal bridges and consequently may lead to plaster loosening in such areas.
- Refer to the Certificate holder's instructions and the project specific site package regarding the installation method and location of the fixings through the reinforcing mesh where fire stops have also been installed. Additional layers of mesh are also applied at these locations. Stainless Steel Fire fixings are to be provided at a rate of one per m² above two stories. The fixing design should take account of the extra duty required under fire conditions.
- Purpose made powder coated aluminium window sills are installed in accordance with the Certificate holder's instructions. They are designed to prevent water ingress and incorporate drips to shed water clear of the system.
- Lamella fire stops are installed in accordance with the Certificate holder's instructions as defined in Section 4.2 of this Certificate, at locations defined in the project specific design package.
- For EPS insulation, any high spots or irregularities should be removed by lightly planing with a rasp to ensure the application of an even thickness of base coat. After sufficient stabilisation of the installed insulation (normally 2 days, during which time the insulation should be protected from exposure to extreme weather conditions to prevent degradation), the insulated wall is ready for the application of the base and finish coats.
- EPS boards exposed to UV light for extended periods prior to the application of the render coatings are subject to breakdown and should be rasped down as required in preparation for rendering.
- Reinforcing coat is mixed and applied, mesh is laid and a further application of reinforcing coat (and mesh if appropriate) is applied to achieve the appropriate thickness (see Table 1).
- Primer is applied to cement based reinforcing coats prior to the application of the selected textured finish.
- Application of the reinforcing coat and finishes should be carried out within the permitted temperature range and should be protected from rapid drying.
- All rendering should follow best practice guidelines e.g. BS 8000-0:2014^[11] and IS EN 13914-1:2016^[1].
- Movement joints shall be provided in accordance with the Specification & Method Statement. For mineral based reinforcing coats, the recommended panel size is 45m² with an aspect ratio of no less than 4:1. For organic based reinforcing coats, panel size is determined by the applicator's management of the project and the location of building movement joints.
- Sealants to be installed in accordance with BS 8000-16:1997+A1:2010^[12] by approved

installers and Sto Ltd. Specification and Method Statement and StoTherm EWI Systems Applicators Training Handbook.

- At all locations where there is a risk of insulant exposure, e.g. window reveals, eaves or stepped gables, the system must be protected, e.g. by an adequate overhang or by purpose made sub-sills, seals or flashings.
- Building corners, door and window heads and jambs are formed using angle beads bonded to the insulation in accordance with the Certificate holder's instructions.
- To minimise the thermal bridge effect during the installation of railings, exterior lighting, shutter guide rails, canopies, aerials, satellite dishes etc, the Certificate holder offers a range of anchoring options. These anchors must be installed in accordance with the Certificate holder's instructions, as defined in the project specific site package, during the installation of the insulation boards.
- Where the external insulation meets intersecting walls etc and the abutting structure cannot be cut back, the edge of the insulation where it meets the wall should be protected using PVC universal stop-trim, followed by the application of a low modular silicone sealant between the top coat and the abutting structure.
- Prior to application of base coat and finish coat, all necessary protective measures such as taping off of existing window frames and covering of glass should be in place.
- If it is not possible to install the ETICS to all external walls, alternative forms of thermal upgrades, such as full fill cavity wall insulation or dry lining should be provided where physically and economically feasible. There should be an adequate overlap at the junction between the ETICS and the alternative insulated method selected to limit thermal bridging at this interface.
- If unusual levels of movement are expected then the use of an expansion joint at the intersection is recommended and should be incorporated into the project specific design provided by the Certificate holder. In the case of un-heated lean-to buildings, the ETICS should continue around the lean-to.
- In sunny weather, work should commence on the shady side of the building and be continued following the sun to prevent the rendering drying out too rapidly.
- The appropriate base coat is prepared in accordance with the manufacturer's instructions, and is trowel applied over the insulation boards no sooner than two days after the adhesive bonding of the boards and after the mechanical fixings have been installed. Base coats requiring the addition of water should be mixed mechanically using a drill and mixer.
- Apply the base coat to the insulation boards to the width of the mesh.
- The reinforcing mesh must be pressed into the base coat with a 100mm overlap. This mesh should be free of rippling or creases and must be fully embedded in the basecoat.
- The mesh should always be embedded in such a way that in the case of thin-layered reinforcement the mesh is in the middle of the base coat layer, and in the case of thick-layered reinforcement it is in the upper third of the base coat layer. The mesh can be laid either vertically or horizontally.
- In the case of double reinforcement, the whole procedure should be repeated before the initial layer dries. Overlaps in each layer when double reinforcing should be offset from one another. The reinforcing mesh should extend over the edges of laths and be cut back once the coat has dried.
- Where required fixings can be installed through the reinforcing mesh. This should be done before the basecoat hardens. Mechanical fixings placed through the reinforcement should be smoothed over with basecoat as soon as they have been installed.
- An additional diagonal reinforcement must be applied around the façade openings. This involves embedding the diagonal reinforcement strips of mesh 200 x 350 mm into the basecoat at a 45° angle in relation to the lines determined by the reveal.
- Base profiles and corner profiles are fixed as specified in the site specific pack. Existing structural expansion joints should be extended through the surface of the ETICS with full system expansion beads.
- The primer and/or finish coat must not be applied until after the base coat has dried out fully (3 days approximately depending on weather conditions).
- On completion of the installation, external fittings, rainwater goods etc are fixed through the system into the substrate in accordance with the Certificate holder's instructions.
- Care must be taken in the detailing of the system around openings and projections.
- All necessary post-application inspections should be performed and handed over to the homeowner accordingly.

Table 1: StoTherm Systems

Type	Storey Height	Insulation	Reinforcement	Fixings	Reinforcing Coat	Finish Coats
StoTherm Classic 5	Refer to Use section on page 2 of this certificate and the purpose group of the existing building	Expanded polystyrene board	Standard: 1 Layer Sto-Glass Fibre Reinforcing Mesh Ground floor and high impact areas: Outer layer: Sto-Glass Fibre Reinforcing Mesh Inner layer: Sto-Armour Mesh	Adhesive: StoLevell Duo Plus and supplementary Mechanical fixings: Notes 3, 4 and 7 Fire fixings: Notes 4 and 6	3mm minimum StoArmat Classic Plus	Stolit Milano, Sto-EcoShapes, Sto Superlit, Sto Lotusan K & MP, StoSlico K,R & MP
StoTherm Vario 4	Refer to Use section on page 2 of this certificate and the purpose group of the existing building	Expanded polystyrene board	Standard: 1 layer Sto-Glass Fibre Reinforcing Mesh Ground floor and high impact areas: Outer layer: Sto-Glass Fibre Reinforcing Mesh Inner layer: Sto-Armour Mesh	Adhesive: StoLevell Duo Plus and supplementary Mechanical fixings: Notes 3, 4 and 7 Fire fixings: Notes 4 and 6	3-5mm minimum StoLevell Duo Plus	Stolit Milano, StoClayer B, Sto Superlit, Sto Lotusan K & MP, StoSlico K,R & MP, StoMiral K,R & MP
StoTherm Mineral 6	Refer to Use section on page 2 of this certificate and the purpose group of the existing building	Mineral fibre board (MFB)	Standard: 1 layer Sto-Glass Fibre Reinforcing Mesh in outer layer of reinforcing coat. Ground floor and high impact areas: Outer layer: Sto-Glass Fibre Reinforcing Mesh Inner layer: Sto-Armour Mesh	Adhesive: StoLevell Duo, and Mechanical: Notes 3, 4 and 5 Fire fixings: Notes 3, 4 and 5	5-10mm minimum StoLevell Duo Plus applied in 2 coats	Sto Superlit, StoSlico K,R & MP, StoMiral K,R & MP

Notes:

- 1 Finish Coats come in various grain sizes including 1mm, 1.5mm, 2mm, 3mm, 6mm.
- 2 Decorative Coats for each system are StoColor Dryonic, StoColor X Black & StoColor Silco.
- 3 Mechanical fixings to be provided in accordance with the project specific design requirements based on pull-out test results. Fixings to be Ejotherm NKU, Ejotherm STR U, Ejotherm STR U 2G and Ejotherm SDK U. Fixings to be recessed into and fixed through insulation, minimum rate 4/m².
- 4 In addition to adhesively fixing with StoLevell Duo Plus, all mineral fibre board is mechanically fixed. Mechanical fixings to be provided in accordance with the project specific design requirements based on pull-out test results. Mechanical fixings to be Ejotherm NKU, Ejotherm STR U, Ejotherm STR U 2G and Ejotherm SDK U. For mineral fibre board, Ejotherm STR U, Ejotherm STR U 2G and Ejotherm SDK U fixings to be recessed into and fixed through insulation, minimum rate of 8/m².
- 5 Fixing of fire barriers:
 All mineral wool fire barriers are
 a) adhesively fixed using StoLevell Duo Plus adhesive.
 b) mechanically fixed as follows:
 - Horizontal fire barriers: Stainless steel mechanical fixings through first layer of mesh and into structural substrate at maximum 1 m centres.
 - Vertical fire barriers: Stainless steel mechanical fixings through first layer of mesh and into structural substrate at maximum 0.5 m centres.
 - EJOT Insulation Support Anchor / Sto Stainless Steel fire fixing.
 - Note the requirements (minimum 4 per m²) of Supplementary Fixings and Insulation Dowels for EPS, requirements for MF, Lamella insulation in StoTherm EWI Systems Applicator Training Handbook, and Figure 11.
- 6 The inclusion of mechanical fixings may introduce a cold bridge and may result in the appearance of light spots in the render finish. Where fixings are provided through the mesh, a 200mm x 200mm patch of mesh should be laid over the fixing location to ensure continuity of surface. Positive fixings must be provided around all window and door openings to ensure adequate and robust edge restraint over the design life.
- 7 Services/Fittings: Secure supports to be provided for soil and rainwater pipe brackets, aerials, lighting, cameras, signage, etc in accordance with **Sto Ltd. Specification and Method Statement** using as appropriate.

Table 1: Product Range, Components and Fixing Requirements

Table 2: Component Specifications and Supply Details

Component	Description	Dimensions/Quantity	Container
Insulation			
EPS Expanded Polystyrene Board	Factory made Expanded Polystyrene product for thermal insulation of buildings to IS EN 13163:2012+A2:2016 Available in White and Silver KORE Sheet EPS70 White KORE Sheet EPS70 Silver KORE Sheet EPS100 Silver KORE Sheet EPS 200 White KORE Sheet EPS 300 White	70mm-300mm thickness	Polythene shrink wrapped package
MFB Mineral Fibre Board	Factory made Mineral Wool product for thermal insulation to IS EN 13162:2012+A1:2015 ROCKWOOL External Wall DD Slab		Polythene shrink wrapped package
MHD Mineral High Density Board	Factory made Mineral Wool product for thermal insulation to IS EN 13162:2012+A1:2015 ROCKWOOL Wall HD Slab		Polythene shrink wrapped package
MFL Mineral Fibre Lamella	Factory made Mineral Wool product for thermal insulation to IS EN 13162:2012 ROCKWOOL Façade Slab Sto-Mineral Fibre Lamella		Polythene shrink wrapped package
Meshcloth			
Sto-Glass Fibre Reinforcing Mesh	Alkali-resistant reinforcing mesh	Mesh width : 6 x 6 mm Width 110 cm	Roll
Sto-Armor Mesh	High-strength reinforcing mesh	Mesh width : 7.5 x 7.5 mm Width : 100 cm	
Substrate Preparation			
	Depending upon specific site conditions, there may be a requirement for additional surface pre-treatment(s). Below is a list of pre-treatment options. Please consult Sto Ltd. for confirmation of suitability. StoPrim Fungal: Water-based special disinfectant solution for pre-treating surface subject to algae and fungal attack. StoPrim Micro: Deep priming concentrate with low solvent content on a silicone microemulsion base. StoPrep Contact: Bonding Bridge for smooth substrates for subsequent plaster coatings. Sto Flexyl: Organic filler waterproofing and for protection from moisture. StoPrim Activ: A two-component corrosion-proofing adhesion primer on an epoxy resin base.		
Reinforcing Coat			
StoArmat Classic Plus	Organic, cement-free reinforcing compound/base coat with large texturing grain. Nominal Thickness 3-4mm on EPS, 4-5mm on Mineral Fibre Board.	3.5-4.5kg/m ² for EPS foam boards and 5-5.5 kg/m ² for Mineral Wool Insulation boards for nominal thicknesses.	25kg Pail
StoLevel Duo Plus	Mineral bonding and reinforcing mortar/base coat. Nominal Thickness 3-4mm onto EPS and +5mm on Mineral Fibre Board.	4.5-6kg/m ² for EPS foam boards and 6-7kg/m ² for Mineral Wool Insulation boards for nominal thicknesses.	25kg bag
Primer/Synthetic Finishes			
Sto Primer (Putzgrund)	A water based alkali resistant primer for use on mineral substrates prior to application of finish render. A low temperature version (QS) is available for use down to 1°C.	coverage 0.3kg/m ² per coat	23 kg pail
StoSilco/Sto Silico QS	Cement free silicone resin render.	Coverage 2.4 to 4.5kg/m ² depending on texture size	25 kg pail
Stolit Effect/Stolit QS K/ Stolit Milano	Organic, coarse-grained free-style textured render.	Coverage 1.5 to 5kg/m ² depending on texture size	25 kg pail

Primer/Synthetic Finishes			
Sto Lotusan K/MP	Finishing render with Lotus-Effect® Technology for-grained free-style textures.	Coverage 1.5 to 4.03kg/m ² depending on texture size	25 kg pail
StoSilco K, QS K	Silicone resin finishing with a stippled texture.	Coverage 1.5-4.30kg/m ² depending finish type	25 kg pail
Sto Miral Dry Dash (Note Not a Dry Dash System but a Polymer Render)	One coat and Dry Dash traditional polymer modified render for new and existing substrates.	Coverage 1.2-1.5kg/m ² per mm thickness applied	25kg bag
StoCleyer B	Resin brick slips, optimised for insulation systems.	coverage relates to shape	box
Sto EcoShapes	Prefabricated render elements for customised facade decoration.	coverage relates to shape	box
StoSuperlit	Organic natural stone render.	coverage 5-6kg/m ² per coat	pail

Table 2: Component Specifications and Supply Details *

* Note StoTherm EWI Systems Applicator Training Handbook and/or Sto TDS or DOP for further information

Table 3: Ancillary Items		
Component	Description	Dimensions/Quantity
StoFoam Elast 600	StoFoam Elast 600	Aerosol can
Sto-Starter Track Universal -	Aluminium profile for the plinth area	Varies
Sto Ltd. profiles	Range of standard profiles include: Sto PVC Mesh Angle Beads-Standard Sto Armour Angle Sto-Drip Edge Profile DP	Varies
Sto Ltd. profile fixings	A range of fixings are available to suit insulation thickness and substrate type, including stainless steel screws, polypropylene plug type with steel expansion pins, and integral plastic expansion sleeve with mushroom heads and steel screw/pin insert. Fixings are specified on a project specific basis, based on pullout strength tests and loading calculations. Where non-stainless steel fixings are used, they must be completely protected in an integral plastic plug and end cap.	Varies
Sto Ltd. Sealants	Sto-Seal Bead Expert Sto-Seal Bead Supra Sto-Joint Sealing Tape Lento	Varies
Fixing into/through system *	Ejotherm NTK U Nailed-in plastic anchor for fixing of external insulation composite systems with rendering in concrete and masonry	-
	Ejotherm STR U, Ejotherm U 2G and Ejotherm SDK U Plastic anchor for fixing of external thermal insulation composite systems with rendering	-
	EJOT Spiral anchor Spiral anchor to fix lightweight add-on parts to ETICS	-
	EJOT Insulation Support Anchor DMH 8 x L (E and V) Hammer Set Tubular bodied anchor	-
	Sto Thermo Dowel UEX 8/60 Insulation board anchor for External Wall Insulations Systems	-
* Fixing in accordance with EAD 330196 00 0604 Plastics Anchors made of Virgin or Non-Virgin Material for Fixing of External Thermal Insulation Composite Systems with Rendering ^[13] or an ETA.		

Table 3: Ancillary Items *

* Note StoTherm EWI Systems Applicator Training Handbook and/or Sto TDS or DOP for further information

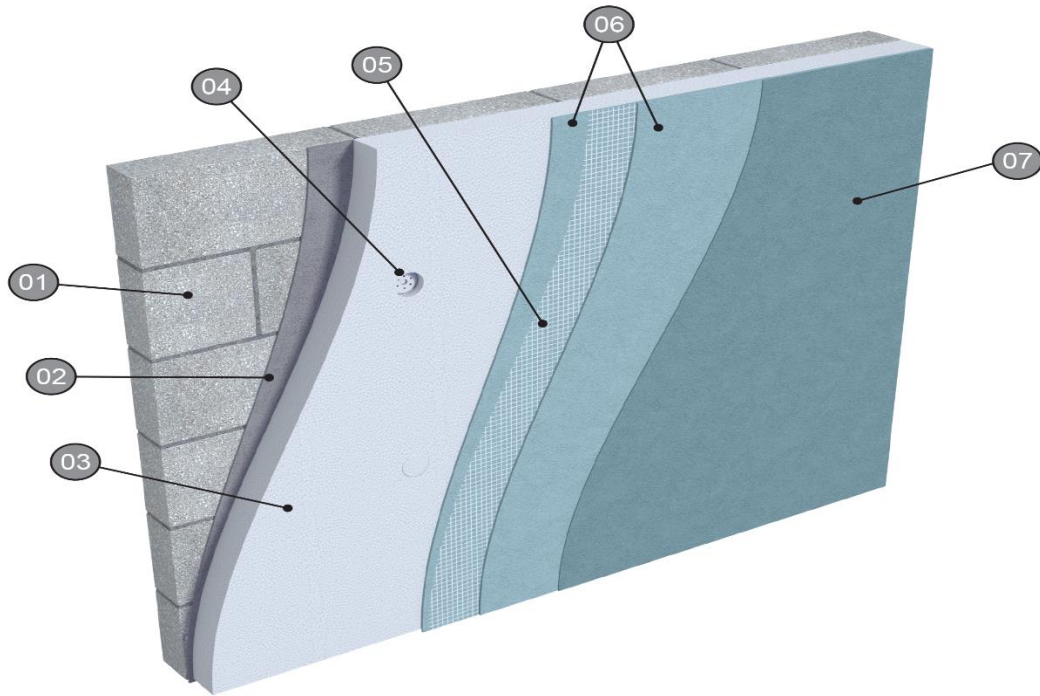

01. Substrate.

02. StoLevell Duo Plus Adhesive.

03. Sto EPS Insulation Board bedded to substrate with Sto adhesive.

04. Sto Thermo Dowel.

05. 1 Layer Sto Glass Fibre Mesh embedded in wet StoArmat Classic Plus. Mesh specification to be upgraded where required in accordance with Table 1.

06. StoArmat Classic Plus.

07. Sto finish as specified.

Figure 1.1: StoTherm Retrofit Classic – Isometric View

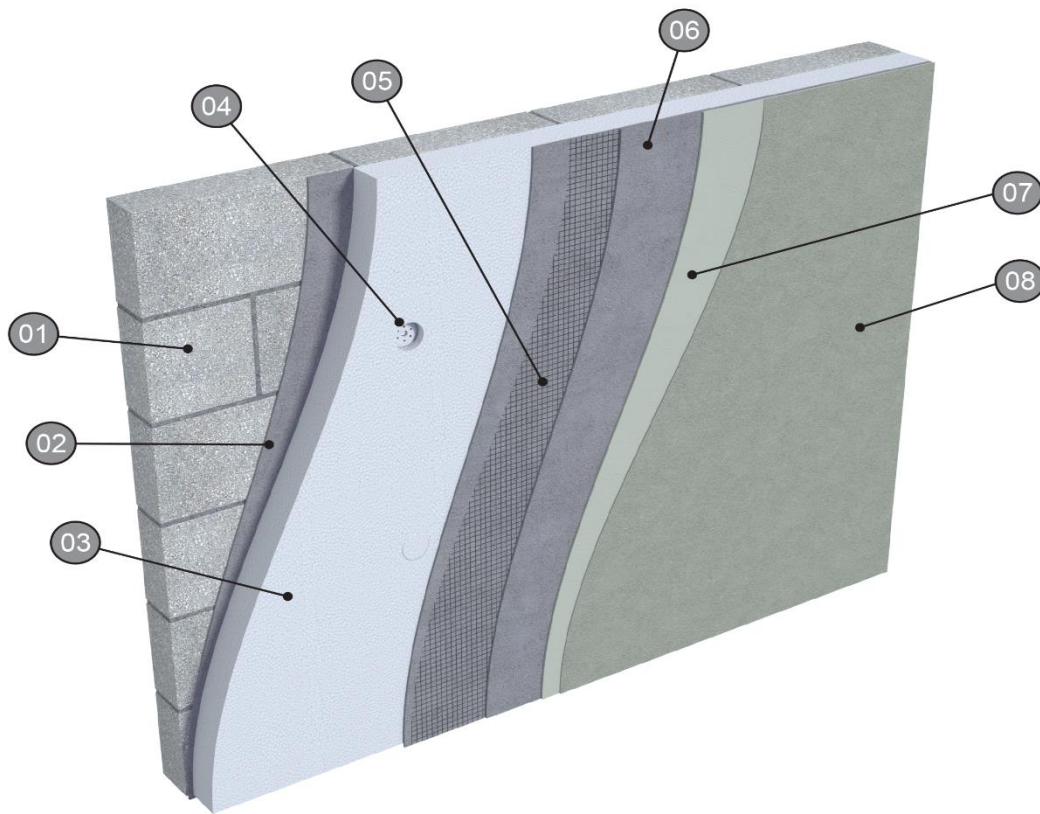

01. Substrate.

02. StoLevell Duo Plus Adhesive.

03. Sto EPS Insulation Board bedded to substrate with Sto Adhesive.

04. Sto Thermo Dowel.

05. Sto Glass Fibre Mesh embedded in wet StoLevell Duo Plus. Additional layer of Mesh to be provided in accordance with Table 1 where necessary.

06. StoLevell DuoPlus.

07. Sto Primer.

08. Sto Finish as specified.

Figure 1.2: StoTherm Retrofit Vario – Isometric View

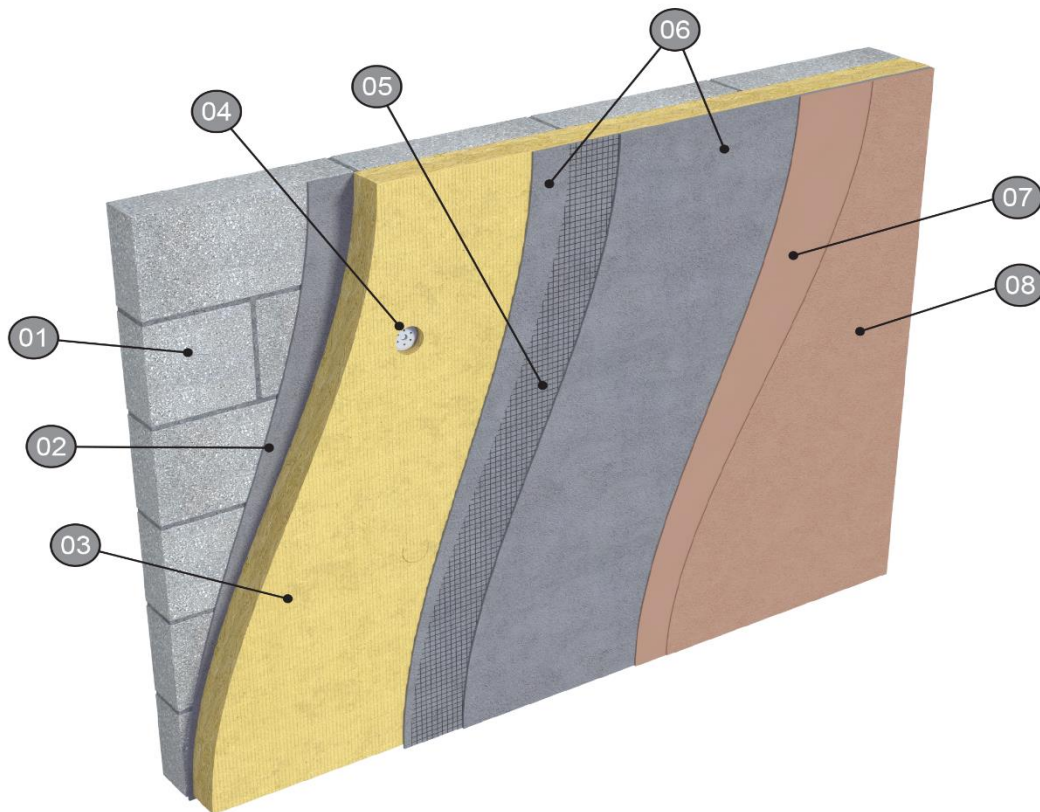

01. Substrate.

02. StoLevel Duo Plus Adhesive.

03. Sto Mineral Fibre Board bedded to substrate with Sto Adhesive.

04. Sto Thermo Dowel.

05. Sto Glass Fibre Mesh embedded in second coat of wet StoLevel Duo Plus.

06. StoLevel DuoPlus.

07. Sto Primer.

08. Sto Finish as specified.

Figure 1.3: StoTherm Retrofit Mineral – Isometric View

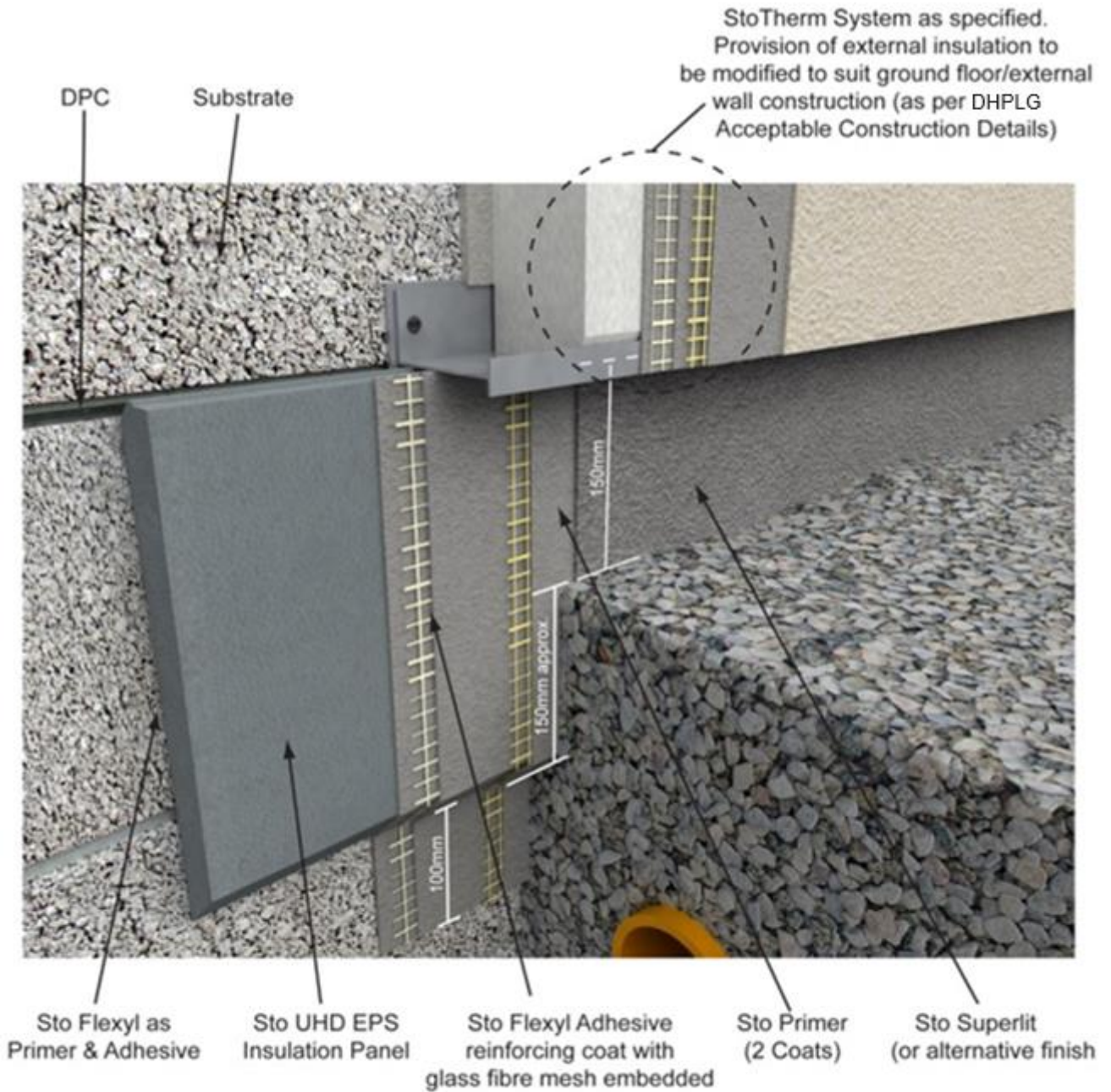

NOTE:
Backfill as specified by Client.
Open french drain shown to reduce splashback

Figure 2: Typical Detail – Insulated Base
* DHPLG now DHLGH

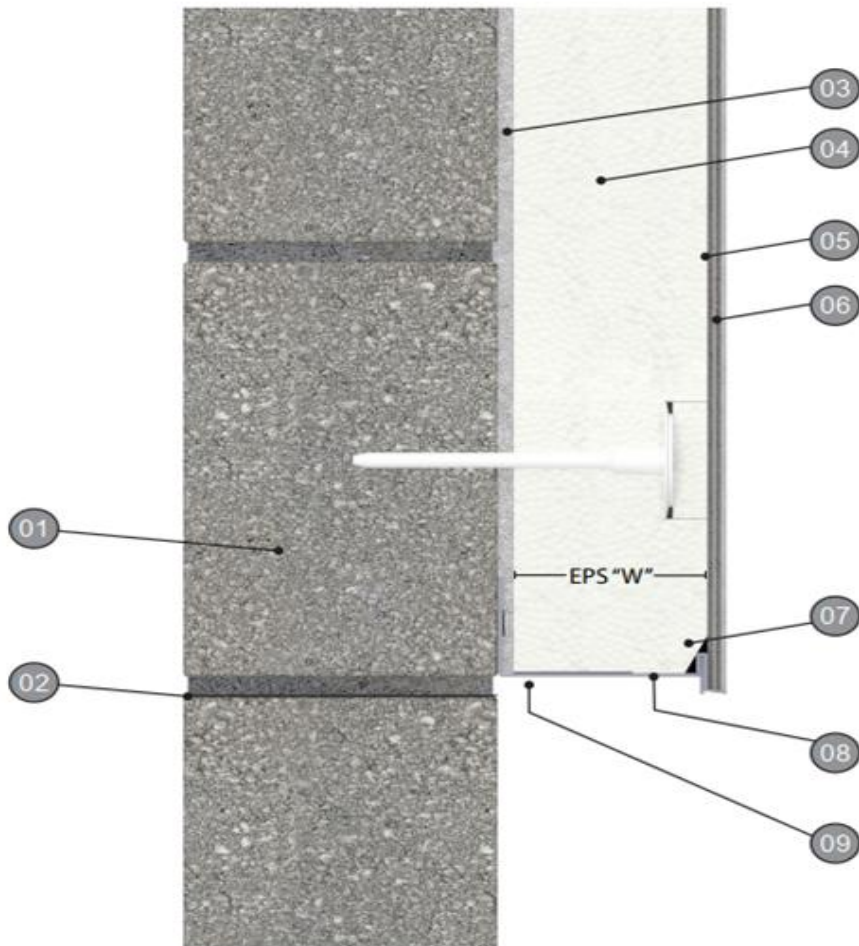

01. Substrate.

02. DPC.

03. StoLevel Duo Plus

04. Sto EPS Insulation Board bedded to substrate with specified adhesive.

05. Sto Armat Classic Plus.

06. 2 Layers mesh.
For details see Table 1.

07. Bottom edge of EPS board to be chamfered to bring face forward with front of starter track.

08. Sto Aluminium Starter Track fixed to substrate (in width to suit thickness of EPS insulation "W").

09. Weep holes to be provided in Sto Aluminium Starter Track.

Figure 3: Typical Detail – StoTherm Retrofit Classic – Aluminium Starter Track

Window Unit and cill to be compatible so as to provided a fully sealed, flush finished joint at interface. Other cill/window interface options must achieve an equivalent standard of sealing, fixity and movement accommodation at the cill/window frame interface and the cill/reveal interface, as the detail shown here. Cill upstand should not interfere with window drainage.

Sto Sill Profile with stop ends, where stop end extends more than 75mm beyond reveal, upstand is not required. Cill have to have minimum fall of 10 degrees.

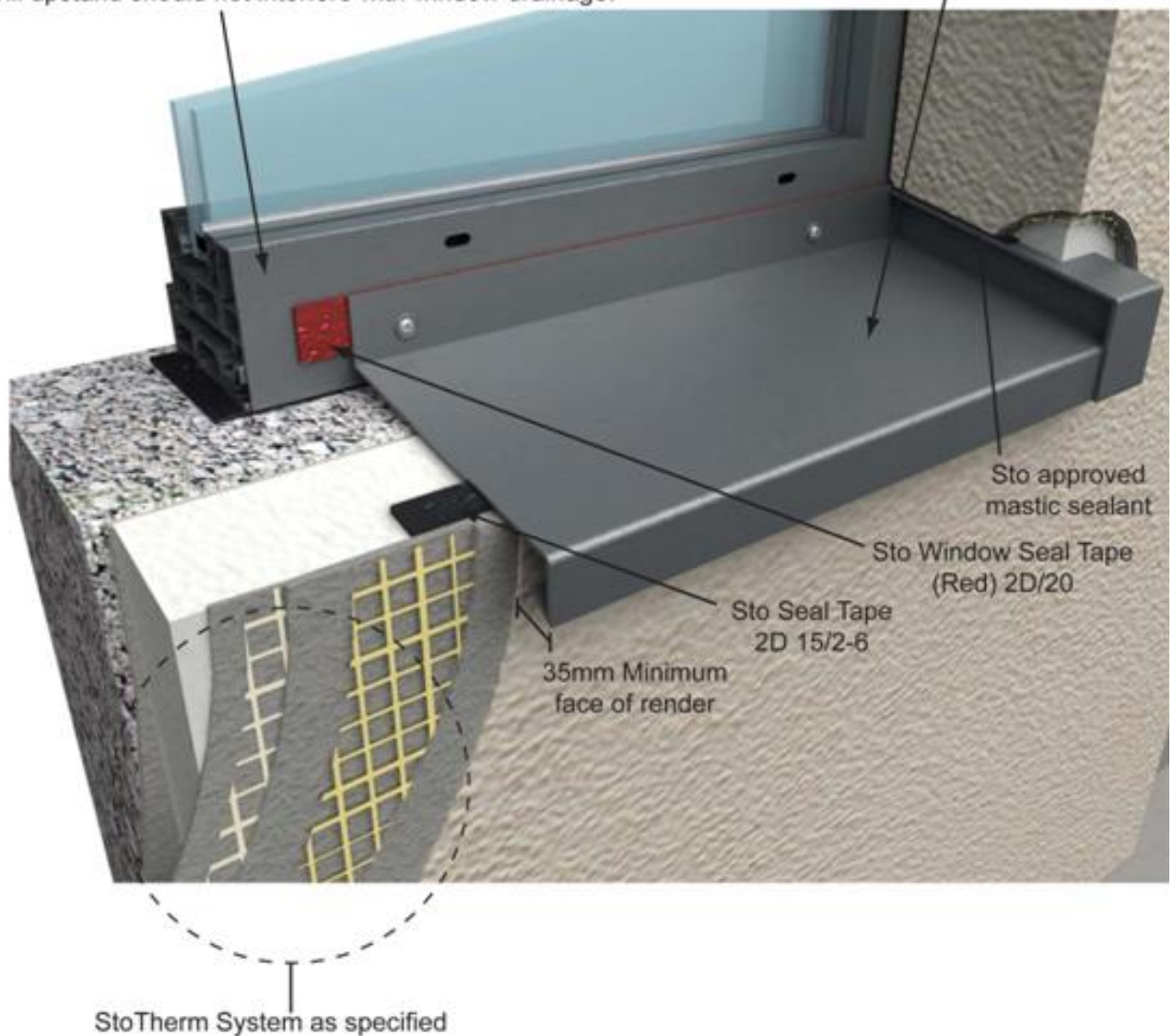
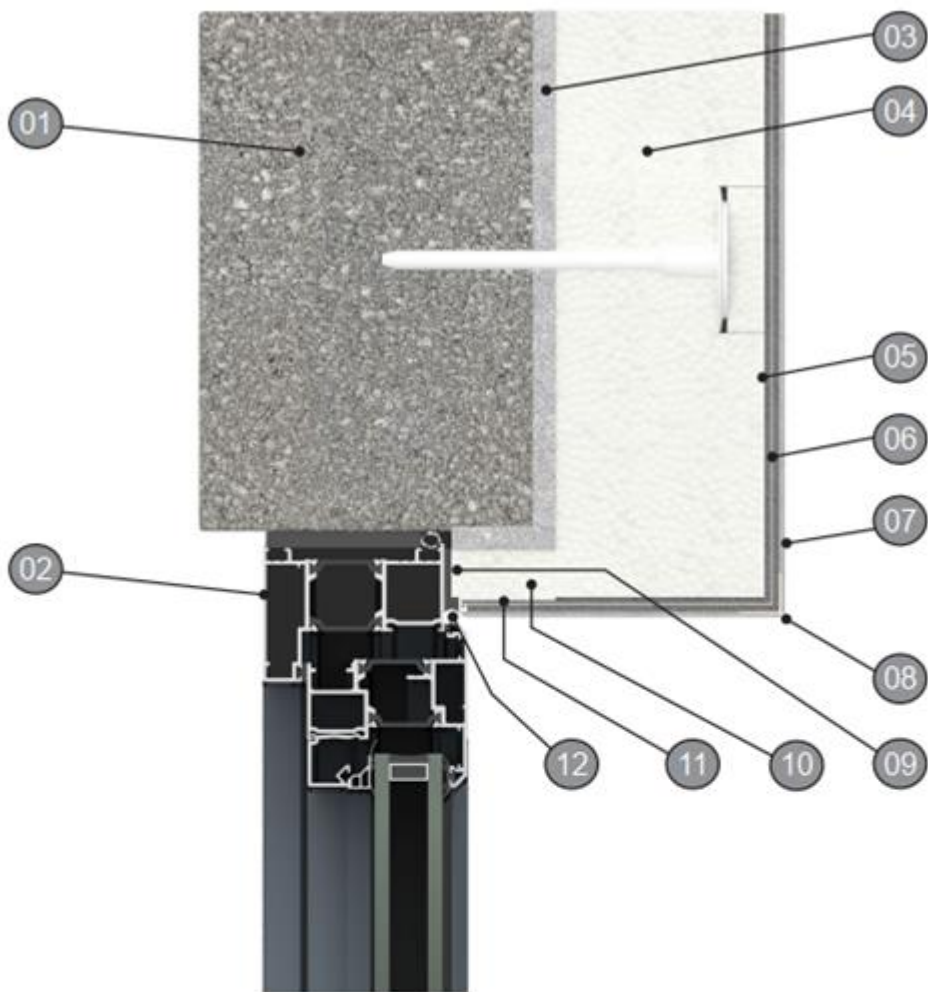

Figure 4: Typical Detail –Sill with Stop End



01. Substrate.

02. Window Head.

03. StoLevell Duo Plus

04. Sto EPS Insulation Board bedded to substrate with specified Sto Adhesive.

05. Sto Armat Classic Plus.

06. 2 Layers mash.
For details see Table 1.

07. Sto Silco finish.
See Table 1 for alternative finishes.

08. Sto PVC Mesh Angle Bead.

09. Sto Seal Tape (Lento).

10. Insulation at reveal to have minimum R-Value of 0.6m²K/w.

11. Sto PVC Stop Bead.

12. Mastic Sealant with regular weep holes provided at 600mm centres.

Figure 5: Typical Detail – StoTherm Retrofit Classic – Window Head

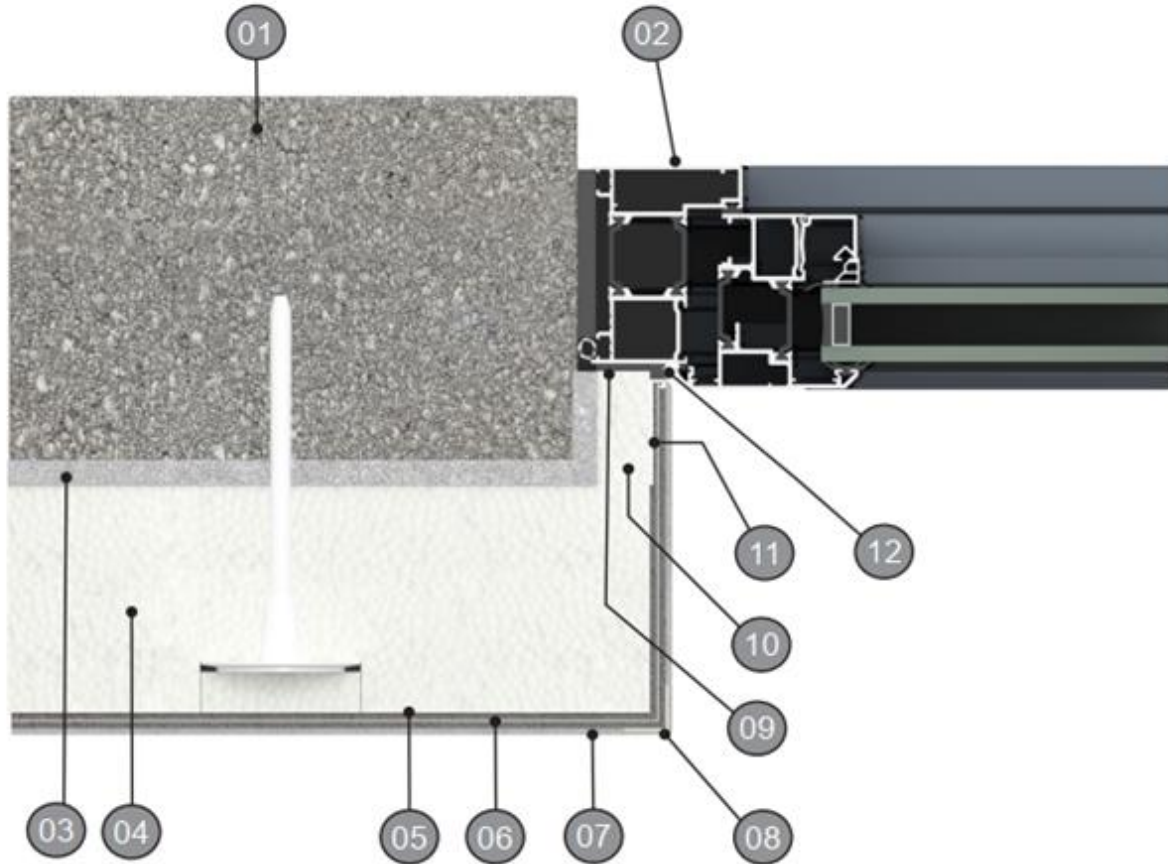

01. Substrate.

02. Window Jamb.

03. StoLevell Duo Plus

04. Sto EPS Insulation Board bedded to substrate with specified Sto Adhesive.

05. Sto Armat Classic Plus.

06. 1 Layer mesh embedded in wet Armat Classic Plus.

07. Sto Silco finish as specified.

08. Sto PVC Mesh Angle Bead.

09. Sto Seal Tape (Lento).

10. Insulation at reveal to have minimum R-Value of 0.6m²K/w.

11. Sto PVC Stop Bead.

12. Mastic Sealant with regular weep holes provided at 600mm centres.

Figure 6: Typical Detail – StoTherm Retrofit Classic – Window Reveal

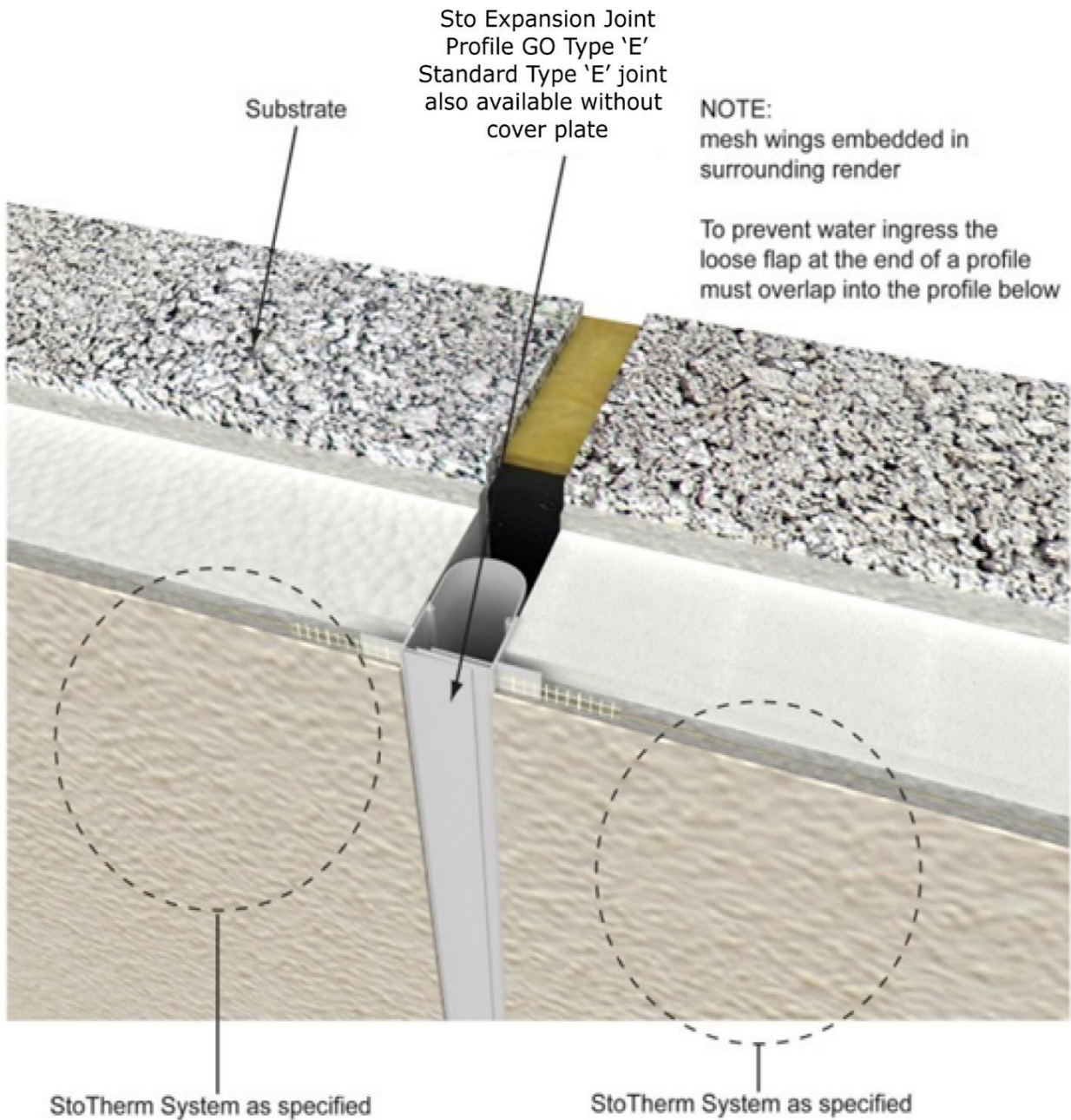
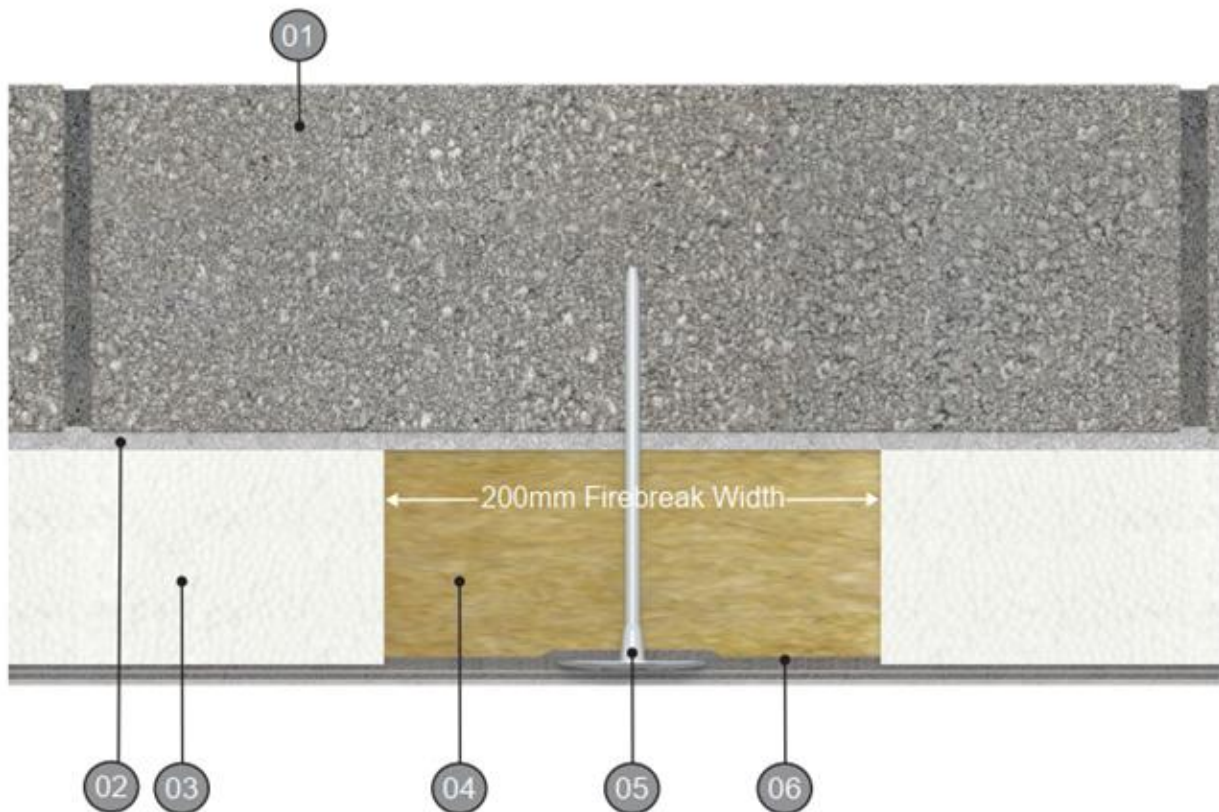

Figure 7: Typical Detail – Vertical Expansion Joint



01. Substrate.

02 StoLevel Duo Plus Adhesive

03. Sto EPS Insulation Board bedded to substrate.

04. Sto Mineral Fibre Lamella bedded to substrate with StoLevel Duo Plus .

05. Sto S/S Firebreak fixing fixed through first layer of mesh @ 1 No. per 500mm vertical centres (maximum).

06. StoLevel Duo Plus applied to face of Lamella prior to application Sto Armat Classic Plus.

Note: Lamella to be fully bonded over entire firebreak width with StoLevel Duo Plus . Minimum vertical overlap at firebreak to be 100mm. EPS boards either side of firebreak should be cut to maintain break bond pattern with overlap of 100mm.

Figure 8: Typical Detail – StoTherm Retrofit Classic – Vertical Fire Barrier

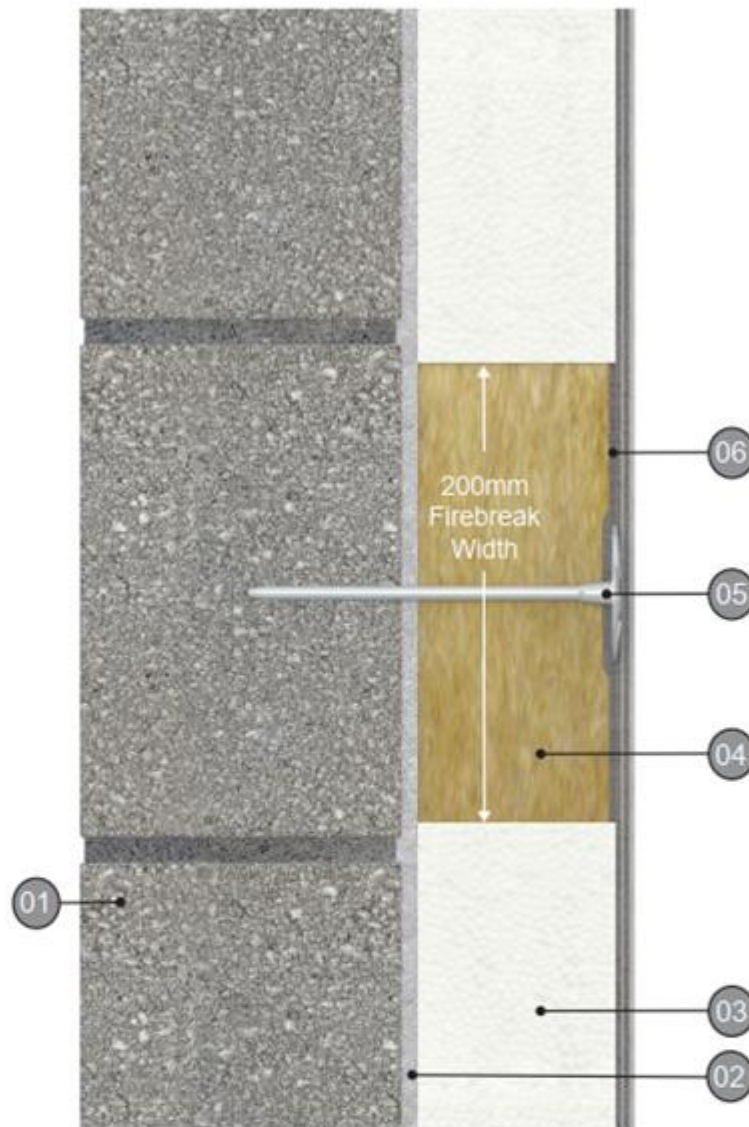

01. Substrate.

02. Sto adhesive as specified.

03. Sto EPS Insulation Board bedded to substrate with StoLevell Duo Plus .

04. Sto Mineral Fibre Lamella bedded to substrate with StoLevell Duo Plus .

05. Sto S/S Firebreak fixing fixed through first layer of mesh @ 1 No. per 500mm vertical centres (maximum).

06. StoLevell-Uni, StoLevell Duo Plus Adhesive applied to face of Lamella prior to application Sto Armat Classic Plus.

Note: Lamella to be fully bonded over entire firebreak width with StoLevell Duo Plus .
Minimum vertical overlap at firebreak to be 100mm. EPS boards either side of firebreak should be cut to maintain break bond pattern with overlap of 100mm.

Figure 9: Typical Detail – StoTherm Retrofit Classic – Horizontal Fire Barrier

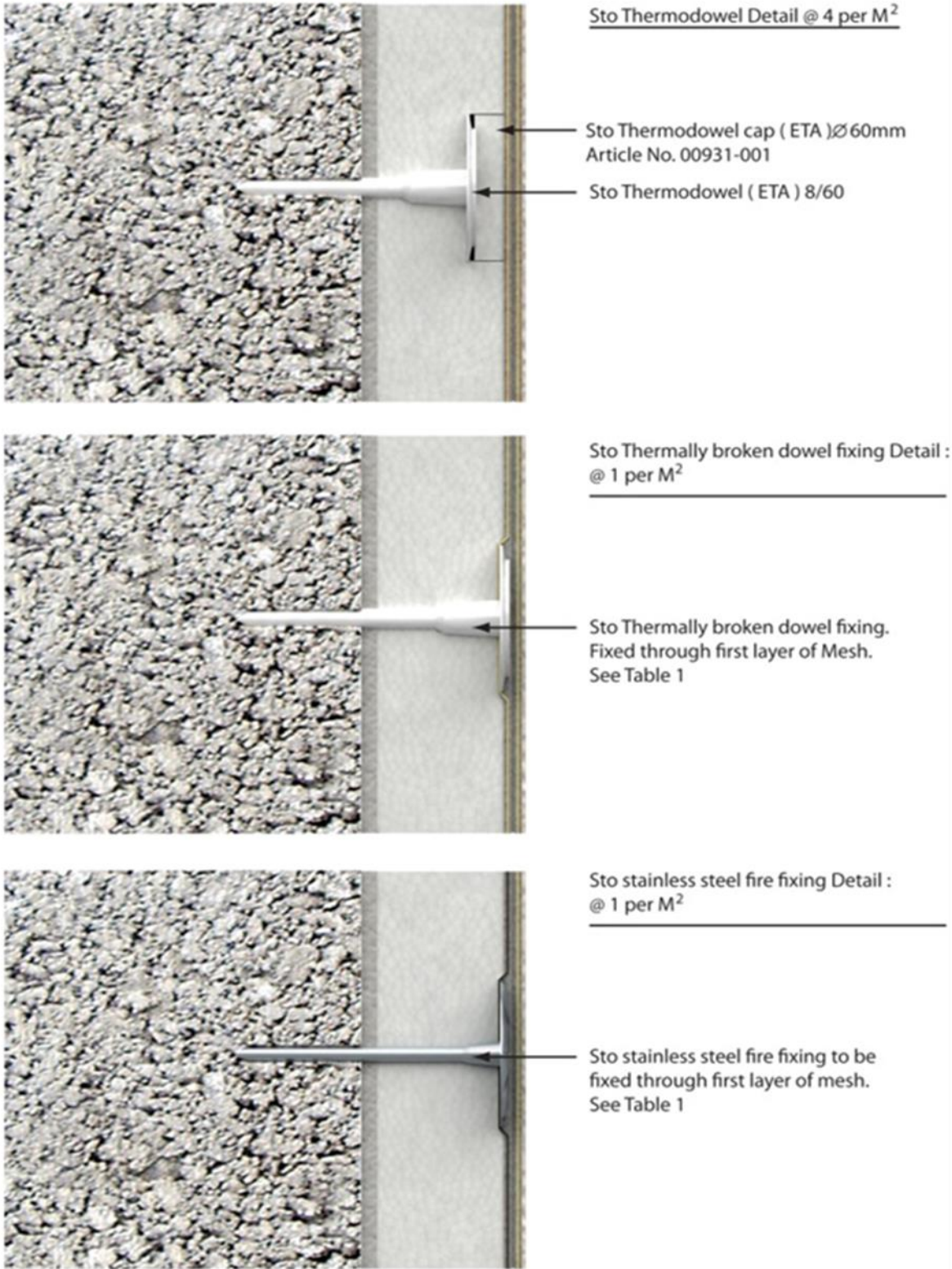

Figure 10: Typical Detail – StoTherm Retrofit Classic – Dowel Positions

- StoTherm dowel between positions - minimum 4 per m² for buildings greater than 2 storeys
- Supplementary dowel positions around Window Aperture, where specified
- StoThermally broken dowel fixing through first layer of Sto Glass Fibre Mesh, where specified

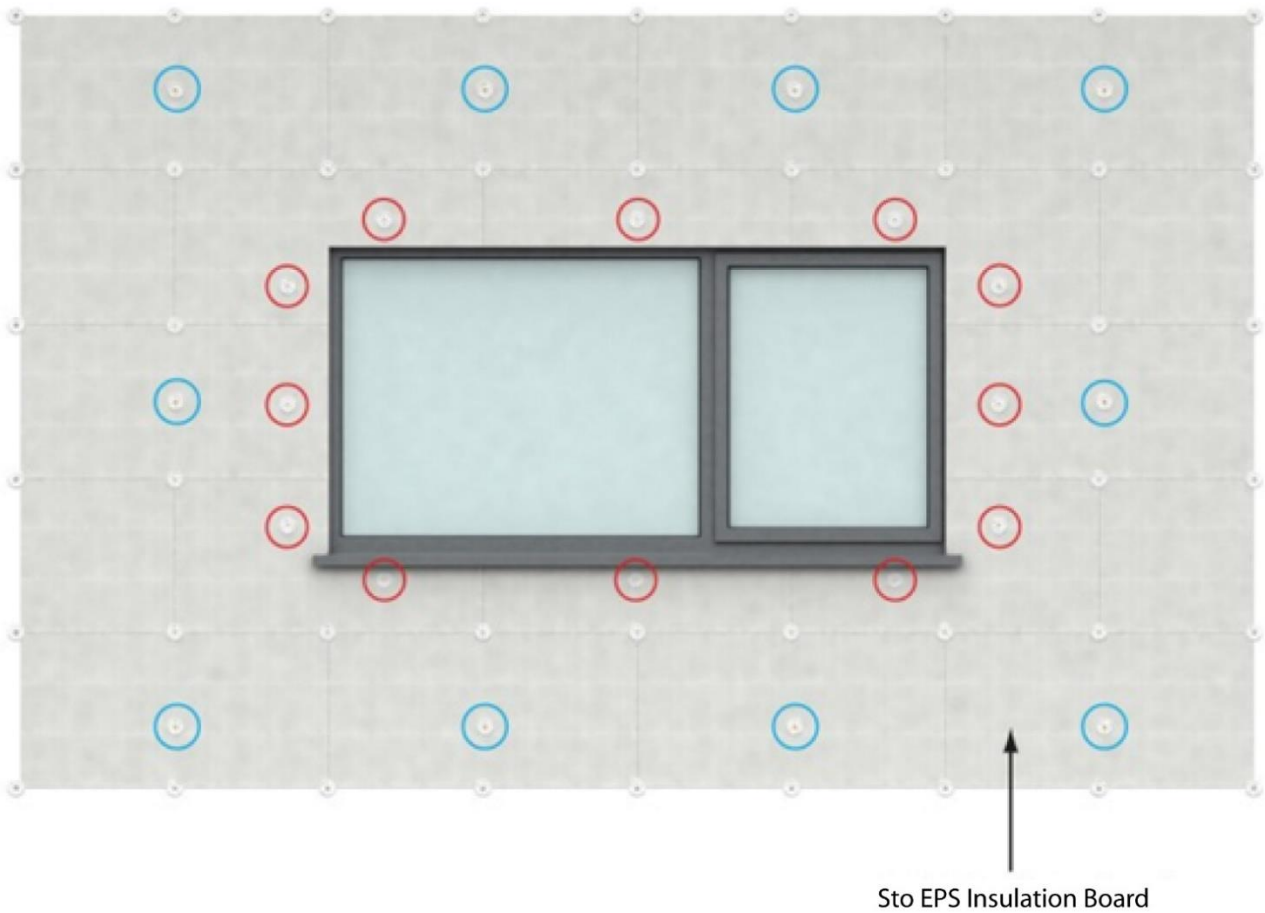

Figure 11: Typical Detail – StoTherm Retrofit Classic – Supplementary Dowel Positions at Openings

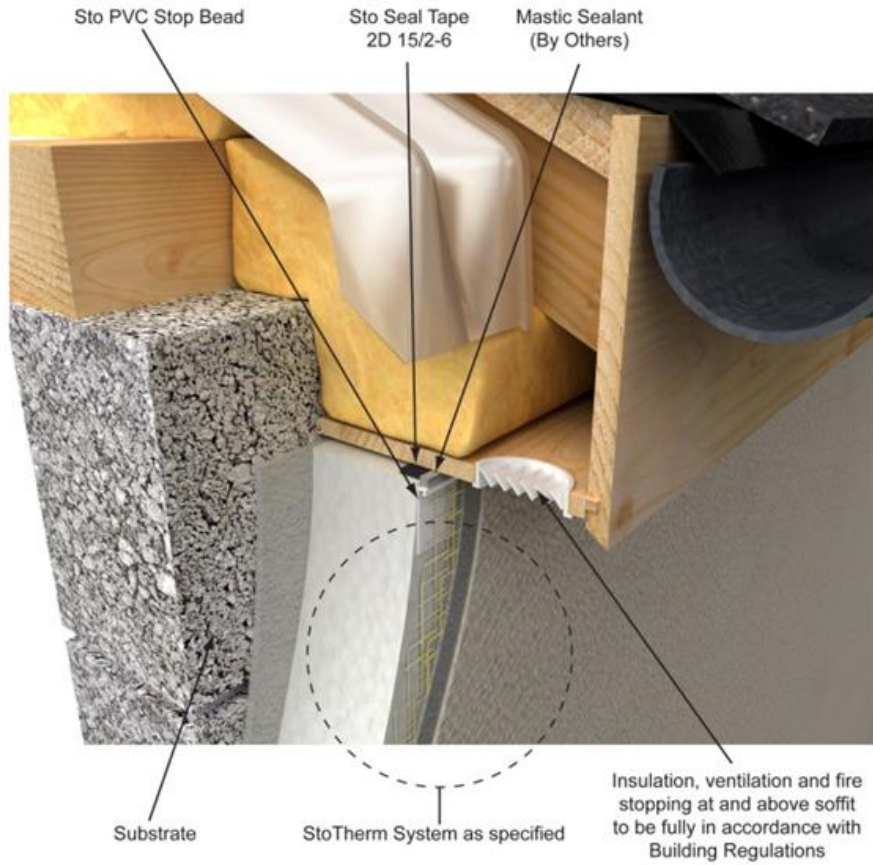

Figure 12: Typical Detail – Eaves

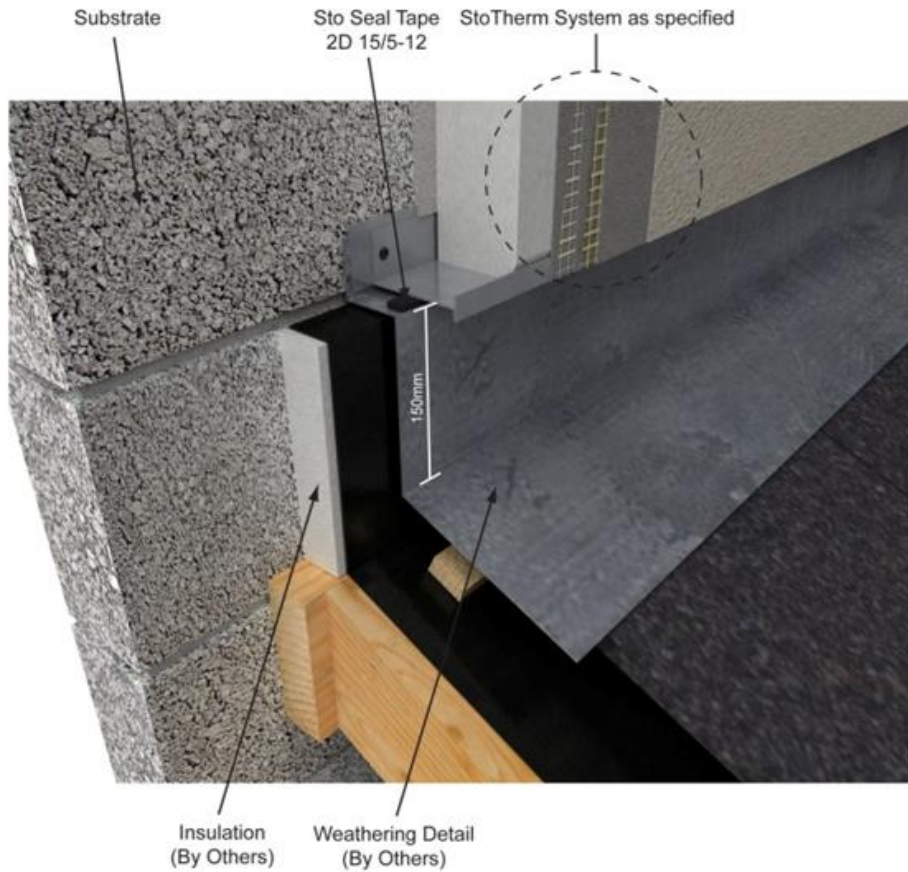

Figure 15: Typical Detail – Stepped Gable

3.1 GENERAL

The system is designed by Sto Ltd. on a project specific basis in accordance with the approved design process. Sto Ltd. assess the building and advise on how to maximise the benefits of the external insulation system for that building. The assessment should take into account any other refurbishment works planned e.g. upgrading of existing windows, replacement of footpaths, eaves and soffits etc., and should aim to increase levels of insulation without compromising any other aspect of the building performance.

The design will include for:

- a) A site survey shall be carried out and recorded.
- b) Evaluation and preparation of substrate.
- c) Minimising risk of condensation in accordance with recommendations of BS5250:2021 Incorporating Corrigendum No. 1. [2] This includes the use of approved detailing incorporating the requirements of SR 54:2014 [3] and Improving Energy Efficiency in Traditional Buildings – Guidance for Specifiers and Installers - DHLGH – 2023 [14], where possible, meeting all of the Acceptable Construction Details published by the DHLGH.
- d) Thermal insulation provision to Part L of the Building Regulations.
- e) Resistance to impact and abrasion.
- f) Resistance to thermal stresses.
- g) Resistance to wind loading.
- h) Design of fixings to withstand design wind loadings, using a safety factor of three for mechanical fixings and a safety factor of nine for adhesive. In addition, fixings around window and door openings shall be at a maximum of 400mm centres in each board or section of board so as to provide positive and robust restraint over the life of the system.
- i) The design for wind loading on buildings greater than two stories should be checked by a chartered engineer in accordance with I.S. EN 1991-1-4:2005 [4].
- j) Design for fire resistance, fire spread and fire stopping.
- k) Design of a water management system to prevent ingress of water at movement joints, windows, doors, openings for services etc. Particular attention is required to ensure that window and sill design are coordinated to achieve a fully integrated design.
- l) Movement joints.
- m) A site-specific maintenance programme.
- n) Durability requirements.

Detailing and construction must be to a high standard to prevent the ingress of water and to achieve the design thermal performance. Consideration should be given to maximising improvement of thermal insulation at window reveals, door openings, sills etc.

Adequate provision should be made at a design and installation stage for release of trapped moisture, e.g. above window heads.

When designed and installed in accordance with this Certificate, the systems will satisfy the requirements of TGD's to Part L of the Building Regulations. The design shall include for the elimination of cold bridging at window and door reveals, eaves and at ground floor level.

The system is intended to improve the weather resistance of the external walls. Seals to windows and doors shall be provided in accordance with the project specific site plan.

Care should be taken to ensure that any ventilation or drainage openings are not obstructed.

In areas where electric cables can come into contact with EPS, in accordance with good practice all PVC sheathed cables should be run through ducting or be re-routed.

Domestic gas installations must not be adversely affected by the fitting of external insulation. If the external insulation has an impact on the gas service line/meter location, then Bord Gáis Networks must be contacted so that a suitable solution can be achieved. If altering a gas installation, a Registered Gas Installer (RGI) must be employed.

In locations where frost heave is likely to occur, plinth insulation must be kept 10mm above ground level. Reference should be made to the StoTherm Applicator Training Handbook.

3.2 Major Renovation

As external insulation over 25% of the building envelope is classified as Major Renovation in TGD to Part L of the Building Regulations, attention should be paid to Section 2.3 of TGD's to Part L where external insulation is undertaken as part of a deep retrofit installation.

4.1 STRENGTH AND STABILITY

4.1.1 Wind Loading

The StoTherm External Wall Insulation Systems can be designed to withstand the wind pressures (including suction) and thermal stresses in accordance with the Building Regulations. The design for wind loading on buildings greater than two stories should be checked by a chartered engineer in accordance with I.S. EN 1991-1-4:2005^[4]. A general factor of safety of 1.5 is applied to design wind loads.

4.1.2 Impact Resistance

- a) The systems described in Table 1 have been classified as defined in Table 5 to be suitable for use as defined in ETAG 004 Table 2, as follows:

Category I: A zone readily accessible at ground level to the public and vulnerable to hard impacts but not subject to abnormally rough use. There are no restrictions on the use of Category I systems.

Category II: A zone liable to impacts from thrown or kicked objects, but in public locations where the height of the system will limit the size of the impact; or at lower levels where access to the building is primarily to those with some incentive to exercise care. Category II excludes use on wall at ground level adjacent to a public footpath, but includes use on properties with their own private walled-in garden.

Category III: A zone not likely to be damaged by normal impacts caused by people or by thrown or kicked objects. Category III is taken to exclude the use on any wall at ground level.

Note: The above classifications do not include acts of vandalism.

In an Irish context, Category II excludes any wall at ground level adjacent to a public footpath but includes on with its own private, walled-in garden. Category III excludes all walls at ground level.

- b) The design should include for preventing damage from impact by motor vehicles or other machinery. Preventative measures such as provision of protective barriers or kerbs should be considered.

4.2 BEHAVIOUR IN RELATION TO FIRE

Systems that achieve a Class B Reaction to Fire Classification are suitable for use up to a maximum 5 storeys (15m) in height for the StoTherm Classic 5, StoTherm Vario 6, and the StoTherm Mineral 6 systems in purpose groups 1(a), 1(b) and 1(d) and up to a maximum of 6 storeys (18m) in height for purpose groups 1(c), 2(a), 2(b), 3, 4(a) and 4 (b) as defined in TGD's to Part B of the Building Regulations. The StoTherm Mineral 6 system is non-combustible with a fire classification of A1 or A2- s1, d0 to IS EN 13501-1^[5] and may be used on heights in excess of this – the Certificate holder must be contacted for the specific build-up, fixing details etc.

Table 7 list the reaction to fire classification according to IS EN 13501-1^[5] for the various build-ups of the StoTherm systems.

With regard to fire stopping of cavities and limitations on use of combustible materials, walls must comply with Sections B3.2, B3.3 and B4 of TGD to Part B and B3.5, B3.6 and B4 of TGD B Volume 2 of the Building Regulations.

Fire fixings to be provided in accordance with Table 1. The fixing design should take account of the extra duty required under fire conditions.

Vertical and horizontal fire barriers shall be provided at each compartment floor and wall, including the second-floor level of a three-storey single occupancy house (see Diagrams 11 and 12 of TGD to Part B Volume 2 of the Building Regulations). Maximum separation between horizontal fire breaks to be 4m (see Figure 7, 8 and 9). Firebreaks should be fully adhesively bonded to the substrate and mechanically fixed with stainless steel fire fixings at maximum 500mm centres (vertical) and 1000mm centres (horizontal).

The fire barrier shall be of non-combustible material, i.e. stone mineral wool slab of minimum density 120kg/m³, be at least 200mm high, continuous and unbroken for the full perimeter of the building and for the full thickness of the insulation. Glass wool is not suitable for use as a firestop.

4.3 PROXIMITY OF HEAT PRODUCING APPLIANCES

Combustible material must be separated from a brick or blockwork chimney by at least 200mm from a flue, or 40mm from the outer surface of the brick or blockwork chimney, in accordance with Section 2 of TGD to Part J of the Building Regulations. Metal fixings in contact with combustible materials should be at least 50mm from a flue.

4.4 THERMAL INSULATION

Assessments were carried out to verify that the requirements of Part L of the Building Regulations can be achieved using the StoTherm External Wall Insulation Systems. The manufacturers' declared thermal conductivity values taken from their CE marking Declarations of Performance are 0.038W/mK for the standard white EPS board, 0.031W/mk for the silver EPS board, and 0.036W/mK for the mineral wool board. These have not been assessed by NSAI Agrément.

When the system is to be applied to a masonry cavity wall, consideration should be given to the treatment of the ventilated cavity. In order to ensure the thermal effectiveness of the external insulation system, it is critical to eliminate airflow within the cavity void. It is essential to seal the cavity to achieve an unventilated air layer. This eliminates heat losses due to airflow within the cavity circumventing the ETIC system. Best practice is to fill the cavity void with an NSAI Agrément approved Cavity Wall Insulation (CWI) system. Ventilation to the building must be maintained in accordance with the requirements of TGD to Part F of the Building Regulations.

4.4.1 Limiting Thermal Bridging

The linear thermal transmittance (ψ) or Psi describes the heat loss associated with junctions and around openings. Window and door reveal design used on the StoTherm External Wall Insulation Systems have been assessed and when detailed in accordance with this Certificate, can meet the requirements of Table D1 of Appendix D of TGD to Part L 2021 (Dwellings) of the Building Regulations.

When all bridged junctions within a building comply with the requirements of this table, the improved 'y' factor of 0.08 can be entered into the DEAP Building Energy Rating calculation. Alternatively if all junctions can be shown to be equivalent or better than the DHLGH publication *Limiting Thermal Bridging & Air Infiltration – Acceptable Construction Details*^[15], then the improved 'y' factor of 0.08 can be used, i.e. R value = 0.6m²K/W for window/door reveals.

Where either of the above options are shown to be valid, this information should be recorded on the 'Certificate of Compliance' for that project for use in future BER calculations.

' ψ ' values for other junctions outside the scope of this Certificate should be assessed in accordance with the BRE IP1/06 *Assessing the effects of thermal bridging at junctions and around openings*, and BRE report BR 497 *Conventions for calculating linear thermal transmittance and temperature factors*, in accordance with Appendix D of TGD's to Part L of the Building Regulations.

4.5 CONDENSATION RISK

Areas where there is a significant risk of interstitial condensation due to high levels of humidity should be identified during the initial site survey e.g. bathrooms and kitchens. Condensation risk analysis will be carried out by Sto Ltd. in accordance with BS 5250:2021^[2], and SR 54 2014 & A2 2022^[3] and Improving Energy Efficiency in Traditional Buildings – Guidance for Specifiers and Installers - DHLGH – 2023 ^[14], and the design modified as appropriate to reduce the risk of surface condensation to acceptable levels.

4.5.1 Internal Surface Condensation

When improving the thermal performance of the external envelope of a building through external wall insulation, designers need to consider the impact of these improvements on untouched elements of the building. As discussed in Section 4.4.1 of this Certificate, thermally bridged sections of the envelope such as window jambs, sills and eaves will experience a lower level of increased thermal performance. The degree of improvement to these junctions can be limited due to physical restrictions on site i.e. footpaths, soffit boards or hinges for windows.

When bridged junctions meet the requirements of Appendix D Table D1 of TGD to Part L 2021 (Dwellings) of the Building Regulations, the coldest internal surface temperature will satisfy the requirements of Section D2, namely that the temperature factor shall be equal to or greater than 0.75. As a result, best practice will have to be adopted in order to limit the risk of internal surface condensation which can result in dampness and mould growth.

When site limiting factors give rise to substandard levels of insulation at bridged junctions, guidance should be sought from the Certificate holder as to acceptable minimum requirements.

4.5.2 Interstitial Condensation

An interstitial condensation risk analysis will be carried out by Sto Ltd. in accordance with BS 5250:2021^[2] and the design modified as appropriate to reduce the risk of surface condensation to acceptable levels.

4.5.3 Ventilation

When installing the external insulation system, the works to be undertaken must not compromise the existing ventilation provisions in the home. When these existing ventilation provisions do not meet the requirements of Part F of the Building Regulations, the homeowner should be informed and remedial action should be taken before the external insulation system is installed.

4.6 MAINTENANCE

Adequate provision should be made, in the initial design phase, for access for inspection and maintenance over the life of the system.

The system shall be inspected and maintained in accordance with the Certificate holder's instructions, as detailed in the Sto Ltd. *Repair and Maintenance Method Statement*. Repairs should be carried out in accordance with the Sto Ltd. method statement for inspection and repair. Repairs to plumbing etc should also be carried out as required to prevent deterioration or damage, and to protect the integrity of the system.

Synthetic finishes may be subject to aesthetic deterioration due to exposure to UV light. They should be re-painted as necessary to maintain appearance. Care should be taken to ensure that the paint used is compatible with the original system and that the water vapour transmission or fire characteristics are not adversely affected (see also Section 4.8.2).

Sealants shall be subject to regular inspection (at least annually). They should be replaced as required and fully replaced every 18 to 20 years to maintain performance.

4.7 WEATHERTIGHTNESS

When designed and detailed in accordance with this Certificate, the system will prevent moisture from the ground coming in contact with the insulation.

The external render has adequate resistance to water penetration when applied in accordance with the Certificate holder's instructions.

Joint designs and sealant specifications were assessed and are considered adequate to ensure that water penetration will not occur, assuming

that regular maintenance is carried out in accordance with the Certificate holder's instructions.

Recommendations for detailing at windows and doors have been assessed and are considered adequate to ensure that water penetration will not occur, assuming that regular maintenance is carried out in accordance with the Certificate holder's instructions.

4.8 DURABILITY

4.8.1 Design Life

An assessment of the life of the system was carried out. This included an assessment of:

- Design and installation controls;
- Proposed building heights;
- Render thickness and specification;
- Material specifications, including insulant, mesh, beading and fixings specifications;
- Joint design;
- Construction details;
- Maintenance requirements;
- Accelerated aging test data.

The assessment indicates that the system should remain effective for at least **30** years subject to normal use, regular inspection and maintenance; providing that it is designed, installed and maintained in accordance with this Certificate. Any damage to the surface finish shall be repaired immediately and regular maintenance shall be undertaken as outlined in Section 4.6 of this Certificate.

Beadings and nosings shall be as shown in building details. The use of exposed plastic beads/nosings for weathering purposes is not permitted.

4.8.2 Aesthetic Performance

As with traditional renders, the aesthetic performance of the systems, e.g. due to discolouration, soiling, staining, algal growth or lime bloom, is dependent on a range of factors such as:

- Type, colour and texture of surface finish;
- Water retaining properties of the finish;
- Architectural form and detailing;
- Building orientation/elevation;
- Local climate / exposure conditions / atmospheric pollution

Adequate consideration should be given at the design stage to all of the above to ensure that the level of maintenance necessary to preserve the aesthetics of the building is acceptable.

4.9 PRACTICABILITY

The practicability of construction and the adequacy of site supervision arrangements were assessed and considered adequate. The project specific designs and method statements for application, inspection and repair were reviewed.

4.10 TESTS AND ASSESSMENTS WERE CARRIED OUT TO DETERMINE THE FOLLOWING

- Structural strength and stability.
- Behaviour in relation to fire.
- Impact resistance.
- Pull-out resistance of fixings.
- Thermal resistance.
- Condensation risk.
- Site erection controls.
- Durability of components.
- Dimensional stability of insulants.

4.11 OTHER INVESTIGATIONS

- (i) Existing data on product properties in relation for fire, toxicity, environmental impact and the effect on mechanical strength/stability and durability were assessed.

- (ii) The manufacturing process was examined including the methods adopted for quality control, and details were obtained of the quality and composition of the materials used.

- (iii) Special building details (e.g. ground level, window and door openings and movement joints) were assessed and approved for use in conjunction with this Certificate.

- (iv) Site visits were conducted to assess the practicability of installation the history of performance in use of the product.

Table 5a: Impact Resistance – StoTherm Classic 5 Systems

Base Coat	Finishing Coat	Reinforcement	Glass Fibre Reinforcing Mesh	Glass Fibre Reinforcing Mesh + Armour Mesh
StoArmat Classic Plus	2mm Sto Silco & Sto Silco QS	Standard: 1 Layer Sto-Glass Fibre Reinforcing Mesh Ground floor and high impact areas: Outer layer: Sto-Glass Fibre Reinforcing Mesh Inner layer: Sto-Armour Mesh	II	I
StoArmat Classic Plus	2mm Stolit & Stolit QS		II	I
StoArmat Classic Plus	2mm Sto Lotusan		I	I
StoArmat Classic Plus	Sto Silco MP + Dash		II	I
StoArmat Classic Plus	Stolit Milano		II	I
StoArmat Classic Plus	Sto Resin Brick Slips		I	I
StoArmat Classic Plus	Sto-EcoShapes		I	I
StoArmat Classic Plus	Sto Superlit		I	I

Table 5b: Impact Resistance – StoTherm Vario 4 Systems

Base Coat	Finishing Coat	Reinforcement	Glass Fibre Reinforcing Mesh	Glass Fibre Reinforcing Mesh + Armour Mesh
StoLevell Duo Plus	2mm Sto Silco & Sto Silco QS	Standard: 1 layer Sto-Glass Fibre Reinforcing Mesh Ground floor and high impact areas: Outer layer: Sto-Glass Fibre Reinforcing Mesh Inner layer: Sto-Armour Mesh	II	I
StoLevell Duo Plus	2mm Stolit & Stolit QS		II	I
StoLevell Duo Plus	2mm Sto Lotusan		II	I
StoLevell Duo Plus	Sto Miral Dry Dash		No performance assessed	No performance assessed
StoLevell Duo Plus	Stolit Milano		III	III
StoLevell Duo Plus	Sto Resin Brick Slips		I	I
StoLevell Duo Plus	Sto-EcoShapes		I	I
StoLevell Duo Plus	Sto Superlit		II	I

Table 5c: Impact Resistance – StoTherm Mineral 6 Systems

Base Coat	Finishing Coat	Reinforcement	Glass Fibre Reinforcing Mesh	Glass Fibre Reinforcing Mesh + Armour Mesh
StoLevell Duo Plus	2mm Sto Silco & Sto Silco QS	Standard: 1 layer	No performance assessed	No performance assessed
StoLevell Duo Plus	2mm Stolit & Stolit QS	Sto-Glass Fibre Reinforcing Mesh in outer layer of reinforcing coat. Ground floor and high impact areas: Outer layer: Sto-Glass Fibre Reinforcing Mesh Inner layer: Sto-Armour Mesh Reinforcement	No performance assessed	No performance assessed
StoLevell Duo Plus	2mm Sto Lotusan		No performance assessed	No performance assessed
StoLevell Duo Plus	Sto Silco MP + Dash		No performance assessed	No performance assessed
StoLevell Duo Plus	Stolit Milano		No performance assessed	No performance assessed
StoLevell Duo Plus	Sto Resin Brick Slips		No performance assessed	No performance assessed
StoLevell Duo Plus	Sto-EcoShapes		No performance assessed	No performance assessed
StoLevell Duo Plus	Sto Superlit		No performance assessed	No performance assessed

Table 5a,5b,5c: Impact Resistance

Existing Wall Structure	Insulation Material	Thermal Conductivity ($\lambda_{90/90}$) of Insulation (W/mK)	U-Value (thickness of insulation) W/m ² K					
			0.27	0.25	0.21	0.17	0.15	0.11
215mm Blockwork	EPS K70 White	0.038	120mm	140mm	170mm	210mm	240mm	340mm
	EPSK70 Grey	0.031	100mm	110mm	140mm	180mm	200mm	290mm
	Dual Density MF	0.036	120mm	130mm	160mm	210mm	230mm	330mm
215 Hollow Blockwork	EPS K70 White	0.038	120mm	140mm	170mm	210mm	240mm	340mm
	EPS K70 Grey	0.031	100mm	110mm	140mm	180mm	200mm	290mm
	Dual Density MF	0.036	120mm	130mm	160mm	210mm	230mm	330mm
Concrete Block Cavity Wall (No insulation)	EPS K70 White	0.038	110mm	130mm	160mm	200mm	230mm	330mm
	EPS K70 Grey	0.031	90mm	110mm	130mm	170mm	200mm	280mm
	Dual Density MF	0.036	110mm	120mm	150mm	190mm	230mm	320mm
Concrete Block Cavity Wall 100/100/100 (50mm Cavity insulation = 0.039W/mk)	EPS K70 White	0.038	70mm	80mm	110mm	160mm	190mm	280mm
	EPS K70 Grey	0.031	50mm	70mm	90mm	130mm	160mm	240mm
	Dual Density MF	0.036	60mm	80mm	100mm	150mm	180mm	280mm
Concrete Block Cavity Wall 100/100/100 (50mm Cavity insulation = 0.033W/mk)	EPS K70 White	0.038	60mm	70mm	100mm	150mm	180mm	270mm
	EPS K70 Grey	0.031	50mm	60mm	80mm	120mm	150mm	240mm
	Dual Density MF	0.036	50mm	70mm	90mm	140mm	170mm	260mm

All calculations assume horizontal heat flow, unventilated cavities >25mm with a thermal resistance of 0.18m²K/W, 18mm of external render $\lambda=1.0$ W/mK. Concrete block thickness as specified - dense solid $\lambda=1.200$ W/mK, dense hollow $\lambda=1.280$ W/mK, medium dense internal $\lambda=0.500$ W/mK. 15mm plasterboard fixing dabs with a thermal resistance of 0.170m²K/W, 12.5mm plasterboard $\lambda=0.190$ W/mK, Grey EPS reference is the Silver EPS.

StoTherm K Systems Typical U-Values based on Modelling of typical housing construction for solid concrete block wall, hollow concrete block wall, concrete block cavity wall, and concrete block partially insulated cavity wall constructions.

Table 6: Typical U-values for StoTherm Systems

StoTherm Classic 5 - Reaction to Fire			
ETICS system description	Maximum declared organic content	Flame retardant content	Class according to EN 13501-1
ETICS StoTherm with rendering system: <ul style="list-style-type: none"> • Adhesives: StoLevell Duo Plus • EPS of thickness up to and including 400 mm (Apparent density < 17 kg/m³) • Glass Fiber Meshes according to table 1 • Base coat: StoArmat Classic Plus • Finish coats: Sto Silco & Sto Silco QS, Stolit & Stolit QS, Sto Lotusan, Sto Silco MP + Dash, Stolit Milano, Sto Resin Brick Slips, Sto-EcoShapes, StoSuperlit* *no performance assessed	base coat ≤ 7.5 % finishing coats ≤ 9.6 %	base coat: min. 10% finishing coats ≥ 7.6 %* *Except Sto Miral: no flame retardant	B-s2,d0

StoTherm Vario 4 - Reaction to Fire			
ETICS system description	Maximum declared organic content	Flame retardant content	Class according to EN 13501-1
ETICS StoTherm with rendering system: <ul style="list-style-type: none"> • Adhesives: StoLevell Duo Plus • EPS of thickness up to and including 400 mm • Glass Fiber Meshes according to table 1 • Base coat: StoLevell Duo Plus • Finish coats: Sto Silco & Sto Silco QS, Sto Miral Dry Dash, Stolit & Stolit QS, Sto Lotusan, Stolit Milano, Sto Resin Brick Slips, Sto-EcoShapes 	base coat ≤ 1.9 % finishing coats ≤ 9.6 %	base coat: no flame retardant finishing coats ≥ 8.0 %* *Except Sto Miral: no flame retardant	B-s1,d0 or B-s2,d0 when using EPS density > 25-30kg/m ³ or use of decorative paint with organic finishing coats

StoTherm Mineral 6 - Reaction to Fire			
ETICS system description	Maximum declared organic content	Flame retardant content	Class according to EN 13501-1
ETICS StoTherm with rendering system: <ul style="list-style-type: none"> • Adhesives: StoLevell Duo Plus • Mineral wool lamella of thickness up to and including 200 mm • Glass Fiber Meshes according to table 1 • Base coat: StoLevell Duo Plus • Finish coats: Sto Silco & Sto Silco QS, Stolit* & Stolit QS*, Sto Lotusan*, Sto Silco MP + Dash, Stolit Milano*, Sto Resin Brick Slips, Sto-EcoShapes, Sto Superlit* *no performance assessed	base coat ≤ 1.7 % finishing coats ≤ 8.7 %	base coat: no flame retardant finishing coats ≥ 7.6 %	A2-s1,d0* *except StoSilco QS: A2-s2,d0

Table 7: Reaction to Fire for StoTherm Systems

StoTherm Vario 4 & Mineral 6		
Base Coat	Finishing Coat	Equivalent Air Layer Thickness s_d
All base coats	All finish coats	$\leq 1.0\text{m}$
StoTherm Classic 5		
Base Coat	Finishing Coat	Equivalent Air Layer Thickness s_d
All base coats	All finish coats	$\leq 2.0\text{m}$

Table 8: Water Vapour Permeability for StoTherm Systems

5.1 National Standards Authority of Ireland ("NSAI") following consultation with NSAI Agrément has assessed the performance and method of installation of the product/process and the quality of the materials used in its manufacture and certifies the product/process to be fit for the use for which it is certified provided that it is manufactured, installed, used and maintained in accordance with the descriptions and specifications set out in this Certificate and in accordance with the manufacturer's instructions and usual trade practice. This Certificate shall remain valid for five years from date of issue so long as:

- (a) the specification of the product is unchanged.
- (b) the Building Regulations and any other regulation or standard applicable to the product/process, its use or installation remains unchanged.
- (c) the product continues to be assessed for the quality of its manufacture and marking by NSAI.
- (d) no new information becomes available which in the opinion of the NSAI, would preclude the granting of the Certificate.
- (e) the product or process continues to be manufactured, installed, used and maintained in accordance with the description, specifications and safety recommendations set out in this certificate.
- (f) the registration and/or surveillance fees due to NSAI Agrément are paid.

5.2 The NSAI Agrément mark and certification number may only be used on or in relation to product/processes in respect of which a valid Certificate exists. If the Certificate becomes invalid the Certificate holder must not use the NSAI Agrément mark and certification number and must remove them from the products already marked.

5.3 In granting Certification, the NSAI makes no representation as to;

- (a) the absence or presence of patent rights subsisting in the product/process; or
- (b) the legal right of the Certificate holder to market, install or maintain the product/process; or
- (c) whether individual products have been manufactured or installed by the Certificate holder

in accordance with the descriptions and specifications set out in this Certificate.

5.4 This Certificate does not comprise installation instructions and does not replace the manufacturer's directions or any professional or trade advice relating to use and installation which may be appropriate.

5.5 Any recommendations contained in this Certificate relating to the safe use of the certified product/process are preconditions to the validity of the Certificate. However the NSAI does not certify that the manufacture or installation of the certified product or process in accordance with the descriptions and specifications set out in this Certificate will satisfy the requirements of the Safety, Health and Welfare at Work Act 2005, or of any other current or future common law duty of care owed by the manufacturer or by the Certificate holder.

5.6 The NSAI is not responsible to any person or body for loss or damage including personal injury arising as a direct or indirect result of the use of this product or process.

5.7 Where reference is made in this Certificate to any Act of the Oireachtas, Regulation made thereunder, Statutory Instrument, Code of Practice, National Standards, manufacturer's instructions, or similar publication, it shall be construed as reference to such publication in the form in which it is in force at the date of this Certification.

NSAI Agrément

This Certificate No. **09/0331** is accordingly granted by the NSAI to **Sto Ltd.** on behalf of NSAI Agrément.

Date of Issue: **17th January 2024**

Signed



Director of Certification

Readers may check that the status of this Certificate has not changed by contacting NSAI Agrément, NSAI, 1 Swift Square, Northwood, Santry, Dublin 9, Ireland. Telephone: (01) 807 3800. Fax: (01) 807 3842. www.n sai.ie

Revisions:

August 2009: Amendment to Figure 5.

11th January 2018: References to Building Regulations and standards updated.

17th January 2024: Revision to reinstate inactive certificate (10/12/2020-16/01/2024) and to reflect applicability for retrofit status for StoTherm Vario 4, StoTherm Classic 5 and StoTherm Mineral 6 systems.

Bibliography

- [1] I.S. EN 13914-1:2016 Design, preparation and application of external rendering and internal plastering – External rendering
- [2] BS 5250:2021 Incorporating Corrigendum No. 1 – Management of moisture in buildings – Code of practice
- [3] SR 54:2014 & A2 2022: Code of practice for the energy efficient retrofit of dwellings
- [4] I.S. EN 1991-1-4:2005/A1 2010: Actions on structures – General actions – Wind actions
- [5] I.S. EN 13501-1:2018 Fire classification of construction products and building elements – Classification using data from reaction to fire tests.
- [6] ETAG 004: External Thermal Insulation Composite Systems (ETICS) with Rendering (Superseded by item 7)
- [7] EAD 040083-00-0404 EAD: 2019: External Thermal Insulation Composite Systems (ETICS) with Renderings
- [8] I.S. EN 13164: Thermal insulation products for buildings - Factory made extruded polystyrene foam (XPS) products – Specification: 2012+A1:2015
- [9] EN13162: Thermal insulation products for buildings - Factory made mineral wool (MW) products – Specification: 2012+A1:2015
- [10] EN13163: Thermal insulation products for buildings - Factory made expanded polystyrene (EPS) products – Specification: 2012+A2:2016
- [11] BS 8000-0:2014 Workmanship on construction sites – Part 0: Introduction and general principles.
- [12] BS 8000-16:1997+A1:2010 Workmanship on construction sites – Code of practice for sealing joints in buildings using sealants
- [13] EAD 330196 00 0604 Plastics Anchors made of Virgin or Non-Virgin Material for Fixing of External Thermal Insulation Composite Systems with Rendering
- [14] Improving Energy Efficiency in Traditional Buildings – Guidance for Specifiers and Installers - DHLGH - 2023
- [15] Technical Guidance Document L – Limiting Thermal Bridging and Air Infiltration – Acceptable Construction Details - 2021